

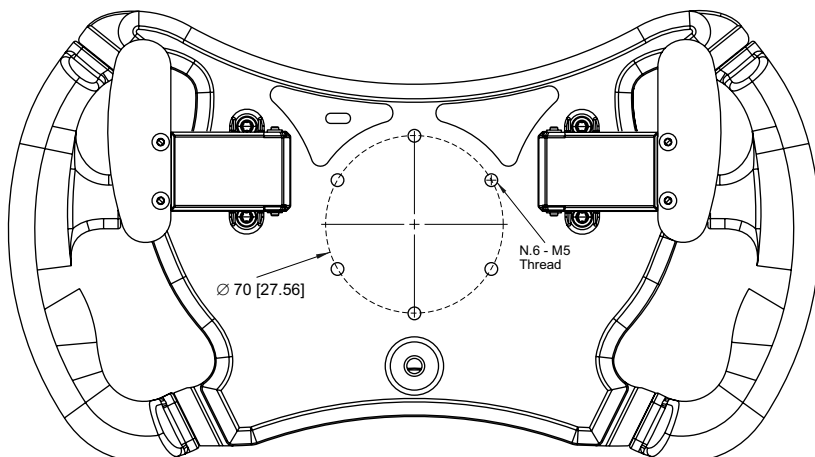

AiM GT32 Standalone

Steering Wheel Open version

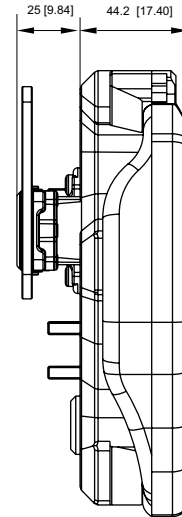
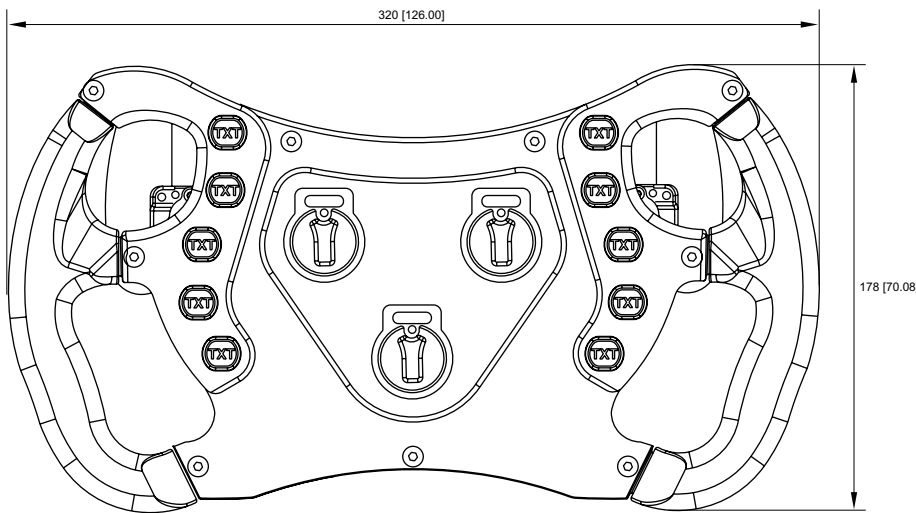

Dimensions in mm [inches]



AiM GT32 Standalone

Steering Wheel Open version

Technical specifications

Diameter	320 mm
CAN connection	1
Body	Anodized aluminum
Pushbuttons	10 pushbuttons (all with RGB backlights)
Rotary switches	3 rotary switches (all with RGB backlights)
Connectors	1 Autosport 22 pins male connector + USB-C connector
Dimensions	320 x 178 x 44.2 mm
Weight	2,600 g
Power consumption	500 mA
Waterproof	IP65

Pinout

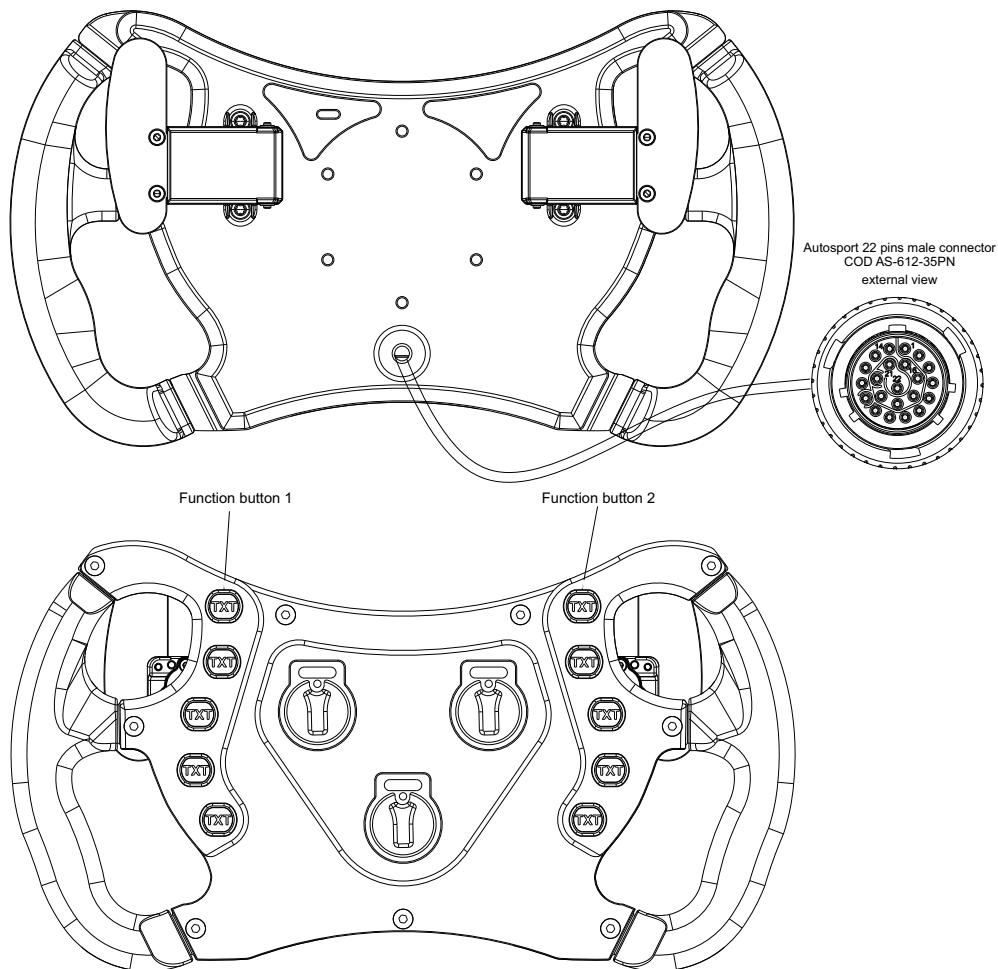

PIN	SIGNAL
1	9-15V Power in
2	NC
3	NC
4	Paddle sh Left
5	Paddle sh Right
6	Paddle sh COM
7	Function button 2
8	NC
9	NC
10	Function button 1
11	Reserved
12	Reserved
13	CAN H
14	GND
15	CAN L
16	Reserved
17	NC
18	Function button 2
19	GND
20	Function button 1
21	Reserved
22	Reserved

All other push buttons and all rotary switches on CAN BUS



AiM GT32 Standalone

Steering Wheel Open version

Connections

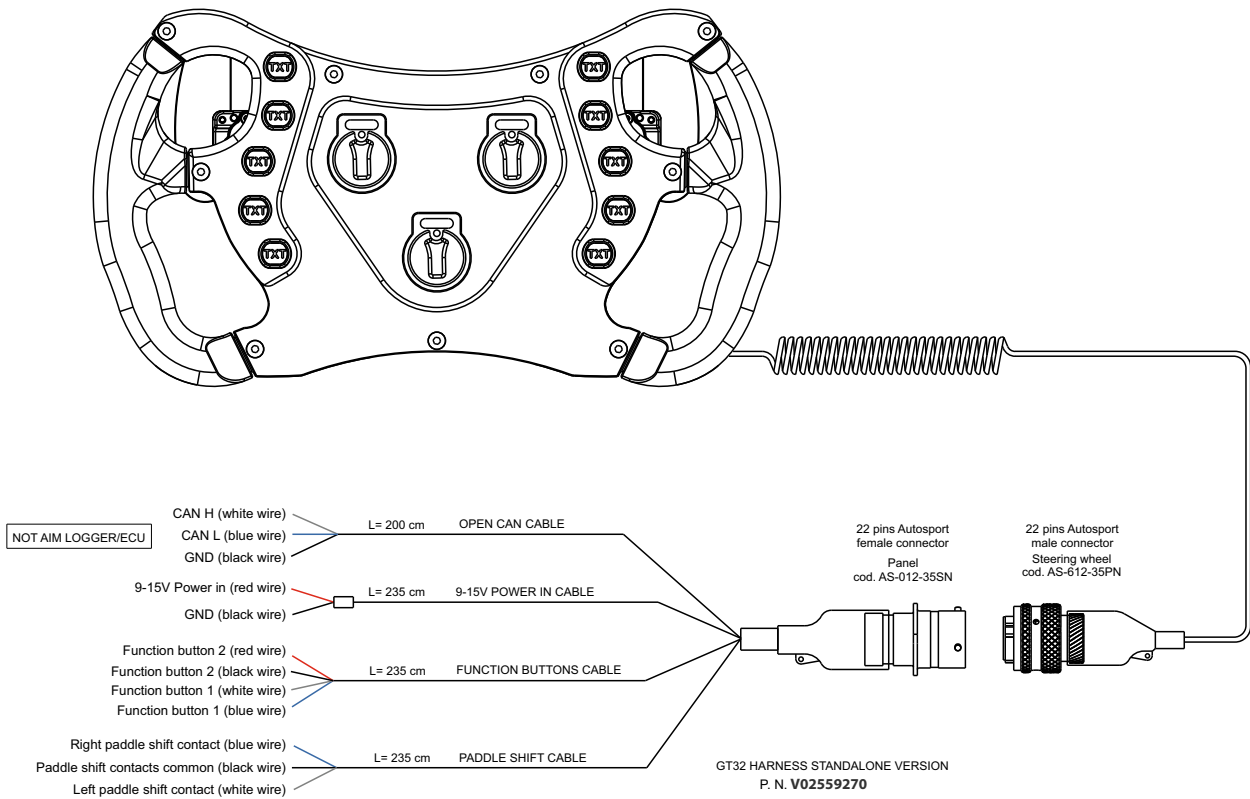

EXTERNAL POWER SUPPLY IS ALWAYS REQUIRED

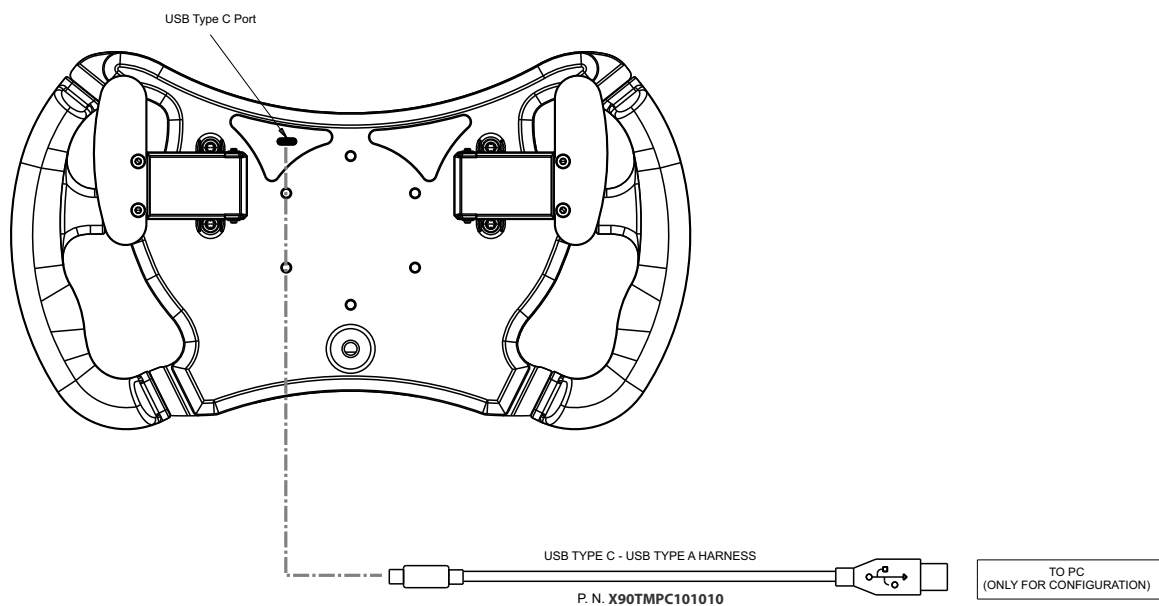















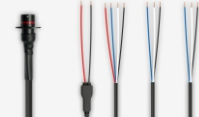

AiM GT32 Standalone

Steering Wheel Open version

Part numbers

Description	Part number	The kit contains			
GT32 Steering Wheel Standalone version + USB Type C - USB Type A Harness	X07GT3200	GT32 Steering Wheel Standalone version 		USB Type C - USB Type A Harness 	
GT32 Steering Wheel Standalone version + GT32 Harness Open version + USB Type C - USB Type A Harness	X07GT320H	GT32 Steering Wheel Standalone version 	GT32 Harness Open version 	USB Type C - USB Type A Harness 	
GT32 Steering Wheel Standalone version + Paddle Shift + USB Type C - USB Type A Harness	X07GT3200P	GT32 Steering Wheel Standalone version 	Paddle Shift 	USB Type C - USB Type A Harness 	
GT32 Steering Wheel Standalone version + Paddle Shift + GT32 Harness Open version + USB Type C - USB Type A Harness	X07GT320HP	GT32 Steering Wheel Standalone version 	Paddle Shift 	GT32 Harness Open version 	USB Type C - USB Type A Harness 

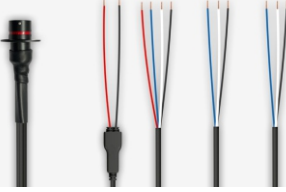
Accessories

Description	Part number	
PaddleShift Right&Left	X07PS	
GT32 Harness Standalone version	V02559270	
USB Type C - USB Type A Harness	X90TMPC101010	



AiM GT32 Standalone

Steering Wheel Open version

Accessories

Description	Part number	
Standard Adhesive Pushbuttons Icons Set (19 pieces)	X07SW4KVT0	
Standard Rotary Switch Set	X07SW4KRT0	