

**User Manual
AiM ECUS
and Spark software**

Release 1.05

AiM Offroad ECUs



SPARK Tuner





INDEX

| | |
|--|----|
| -àè | |
| 1 – Introduction | 4 |
| 2 – Compatibilities | 5 |
| 3 – Taipan Description and connections | 5 |
| 4 – Taipan accessories: handlebar switch and UC Bridge | 6 |
| 4.1 – Handlebar switch | 7 |
| 4.1.1 – Maps management | 8 |
| 4.1.2 – How to apply corrections | 9 |
| 4.1.3 – How to manage traction control | 9 |
| 4.1.4 – How to activate Launch control | 9 |
| 4.1.5 – Configuring the handlebar switch as shift light module | 9 |
| 4.2 – UC Bridge | 12 |
| 5 – ECU Available configurations | 13 |
| 6 – Spark software user license | 14 |
| 6.1 – Software overview | 18 |
| 6.2 – Menu bar | 19 |
| 6.2.1 – File | 19 |
| 6.2.2 – ECU | 20 |
| 6.2.3 – Map | 21 |
| 6.2.4 – Live Measures | 22 |
| 6.2.5 – Diagnostics | 24 |
| 6.2.6 – Updates | 26 |
| 6.2.7 – Options | 28 |
| 6.2.8 – What’s new | 32 |
| 6.3 – Icons bar | 32 |
| 6.4 – Project panel | 36 |
| 6.4.1 – Map Switch/Injection Trims | 38 |
| 6.4.2 – Speed and gear settings (Yarara only) | 39 |
| 6.4.2 – Strategies/Quick shift | 40 |
| 6.4.3 – Vb out | 40 |
| 6.4.4 – CAN Configuration/CAN parameters | 41 |
| 6.4.5 – Maps | 42 |
| 6.4.6 – Expansions | 46 |
| 6.5 – Data Panel | 46 |
| 6.5.1 – Table format | 47 |
| 6.5.2 – Interpolation on: row, column and bilinear | 50 |
| 6.5.3 – Smoothing | 53 |
| 6.5.4 – 2D Format | 54 |
| 6.6 – Live measures panel | 56 |
| 6.7 – Info bar | 57 |
| Appendix A – AiM ECUs and accessories part numbers | 58 |
| Appendix B – AiM ECUs and accessories dimensions and pinout | 59 |
| Taipan/Taipan Y dimensions in mm [inches] | 59 |
| Taipan Y v2 dimensions in mm [inches] | 60 |
| Taipan K dimensions in mm [inches] | 61 |
| Yarara dimensions in mm [inches] | 62 |
| Handlebar switch dimensions in mm [inches] | 63 |
| UC Bridge dimensions in mm [inches] | 64 |
| Taipan pinout | 65 |
| Taipan Y Pinout | 66 |
| Taipan Y v2 pinout | 67 |
| Taipan K Pinout | 68 |
| Yarara pinout | 69 |
| Handlebar switch pinout | 70 |
| UC Bridge pinout | 71 |
| Appendix C – Taipan and Yarara harnesses | 72 |



| | |
|---|----|
| Yarara optional cable pinout | 75 |
| AiM ECUs CAN+External power cable for Solo 2 DL dimensions and pinout | 76 |
| Appendix E – Dictionary | 77 |
| Appendix D – Malfunctioning Indicator Lamp (MIL) – Taipan only | 78 |

1 – Introduction

Taipan/Taipan Y and Yarara are the new AiM ECUs properly designed and developed for off-road-bikes; both the ECU and its accessories can be easily installed on your bike.



Their **part numbers** are:

- Taipan
- Taipan Y*
- Taipan Y v2
- Taipan K
- Yarara

XE1ECUCBO
XE1ECUCB1
XE1ECUTYV2
XE1ECUTK0
XE1ECUYA0

* for Yamaha cross YZ 250 F 2024 and YZ 450F 2023-2024

Each ECU can have **optional accessories** as follows:

- Handle Bar switch
- CAN UC Bridge User version

XE1HBS000
XE1UCB000

Additional cables or harnesses are also available

- All ECUs 2m extension cable
- All ECUs 4m extension cable
- 50cm extension cable for connection with Solo 2 DL
- Analog channels and second injection harness
- Analog channels harness
- Second Injection harness
- CAN+External power cable(**Taipan Y v2 only**)
- CAN+External power cable(**Taipan K only**)
- Solo 2DL/ECU Log CAN+External power cable (**Taipan K only**)
- Yarara additional harness

V02596020
V02596030
V02589120
V02596060
V02596070
V02596080
V02596140
V02596160
V02589180
V02596090

Please refer to “Appendix “C for further information about ECUs accessories, cables and harnesses.

All ECUs are easily installable on most of the off-road bikes, as described in Chapter 3.

2 – Compatibilities

Taipan ECU are compatible with many off road bikes model brands and types; please refer to Taipan → Compatible models page of AiM website at www.aim-sportline.com for further information. This list is constantly updated.

3 – Taipan Description and connections

Taipan features four connectors:

- a main ECU connector supported by most of off road bikes
- a JST CAN connector to connect Taipan to the optional handlebar switch
- a second JST CAN connector to connect Taipan to the optional UC Bridge user version
- a third JST CAN connector for external AiM CAN expansion modules

Please refer to Appendix B to know Taipan pinout.



4 – Taipan accessories: handlebar switch and UC Bridge

Taipan ECU optional accessories are:

- handlebar switch: the fastest way to apply strategies while riding
- UC Bridge the USB to CAN dongle used to make Taipan ECU communicate to Spark user software.

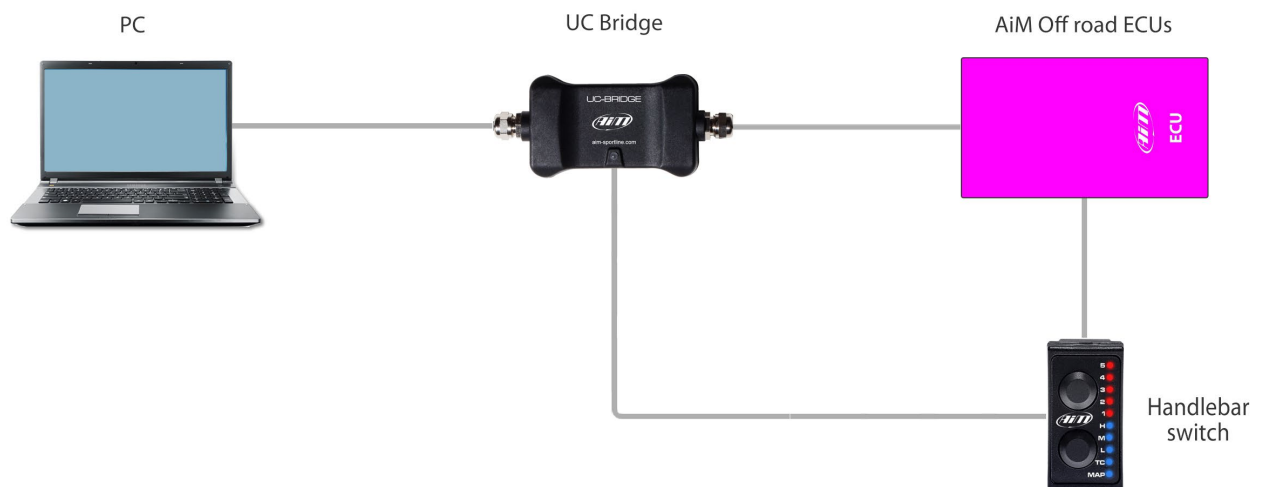

4.1 – Handlebar switch

Handlebar switch is the best way to manage your bike behaviour. It features two pushbuttons and ten LEDs to be used for:

- changing the running map
- applying fuel corrections
- activating traction control
- activating launch control

The two **pushbuttons** are used for:

- top one: scrolling the options of a selected function
- bottom one: scrolling the function to set

By default **LEDs** are used for:

- 5-1: showing the selected map or applying fuel mixture corrections
- HML: showing RPM range (High, Middle, Low)
- TC: Traction Control management
- MAP: MAP management

Please note: as explained in paragraph 4.1.5 LEDs can be configured as shift lights too helping you to change gear

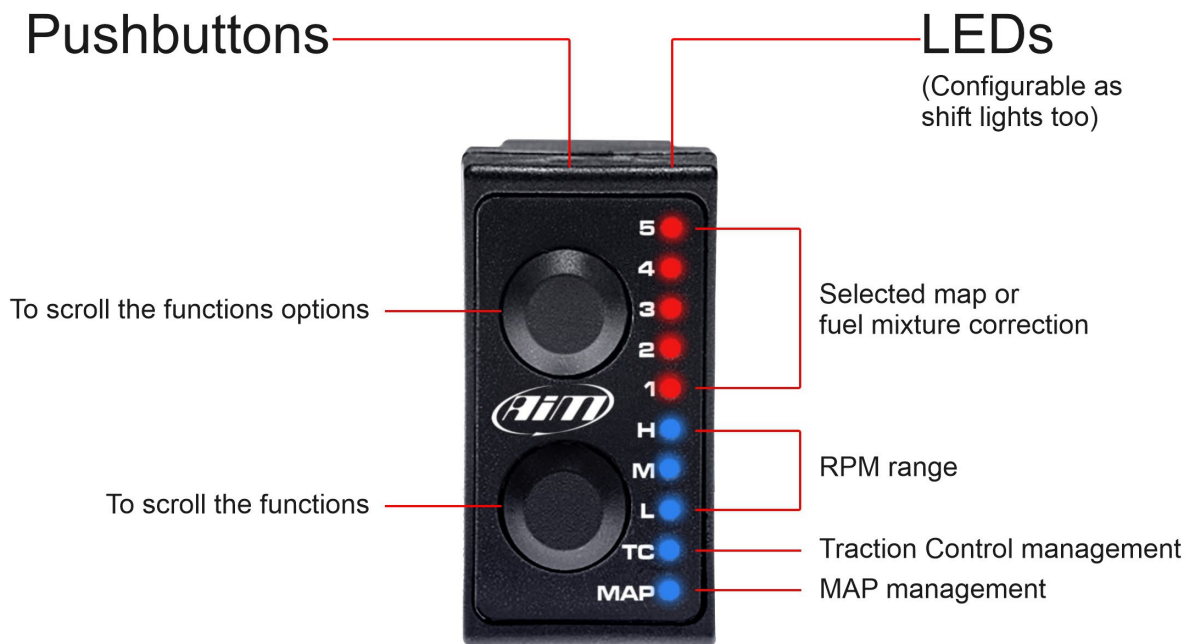

4.1.1 – Maps management

At ECU switch on the handlebar switch is by default set to show the selected MAP, MAP 2 (right image below).

To change the selected MAP:

- keep the lower pushbutton pressed with MAP LED selected
- push upper pushbutton scrolling the different maps
- if the selected map is valid the related LED stays steady (left image below); otherwise the handlebar switch comes back to the previous map setting



4.1.2 – How to apply corrections

A correction is the possibility to get a richer or leaner fuel mixture at different RPM ranges: low, mid, high. RPM threshold and percentage applied along with default values are defined in paragraph 6.4.1 (Map switch – injector trims)

To apply a correction:

- push the lower pushbutton to select at which RPM range (lower, mid or high) you want to set the correction.
- use the upper pushbutton to select a value in the range; assuming for example that 3 corresponds to no-correction value:
- Select Level 3 for no Correction.
- Select Level 4 and 5 for a fatter mixture (5 doubles the percentage chosen).
- Select Level 1 and 2 for a leaner mixture (1 doubles the percentage chosen)

Please refer to paragraph 6.4.1 for further information

4.1.3 – How to manage traction control

Traction control helps preventing driven wheel speed when excess power is applied.

- to **activate** it: keep the lower button pushed until the green LED corresponding to TC turns ON
- to **de-activate** it: press and hold the lower pushbutton again until the green LED turns OFF
- to **manage** it: with TC enabled, use the upper pushbutton to select the strength of the Traction Control strategy 1 being the minimum strength and 5 the maximum.

Please note: Traction Control needs to be enabled for the selected Map: this will be done during the ECU Map configuration (please refer to paragraph 6.4.5 for further configuration).

4.1.4 – How to activate Launch control

Launch control is an electronic aid that helps riders to accelerate from a standing start. To activate it press and hold both upper and lower pushbuttons until LED from 1 to 5 starts blinking red, indicating that the strategy is engaged.

Please note: Launch Control needs to be enabled in the selected map (please refer to paragraph 6.4.5 for further information about launch control enabling/disabling procedure).

4.1.5 – Configuring the handlebar switch as shift light module

A Shift light module is an array of LEDs that begins flashing at a defined RPM value, aiding the rider in optimal shift points. You may use the Handlebar Switch LEDs as a Shift Lights after configuring it as shown below:

- Connect UC bridge to the PC and link the handlebar switch to the UC Bridge through the CAN connector



- Run Spark software
- Follow this path: "File -> Open ECU project"

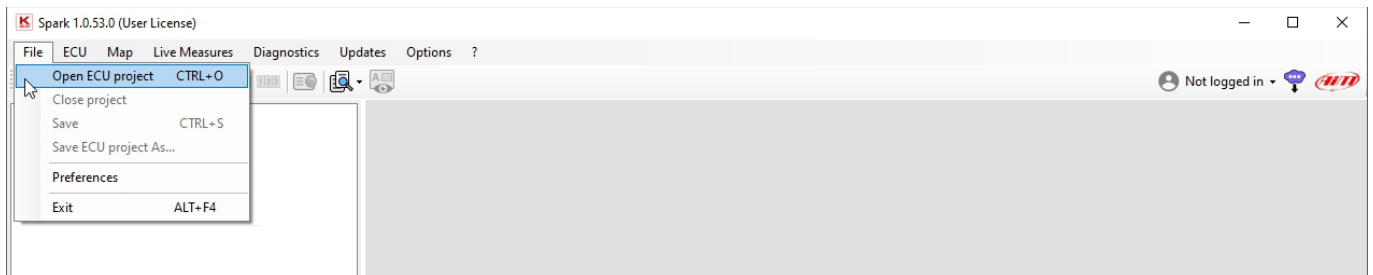

The software opens this path "OS (C:)>AiM_SPORT>Spark>User".

- come back to "OS (C:)>AiM_SPORT>Spark" and follow this path "OS (C:)>AiM_SPORT>Spark>AiM>Base projects>Expansions"
- select "AiM Expansion configuration file (*.axc2)" in the file type menu bottom right of the dialog window
- select the HBS configuration (AiM HBSwitch.axc2 in the example)

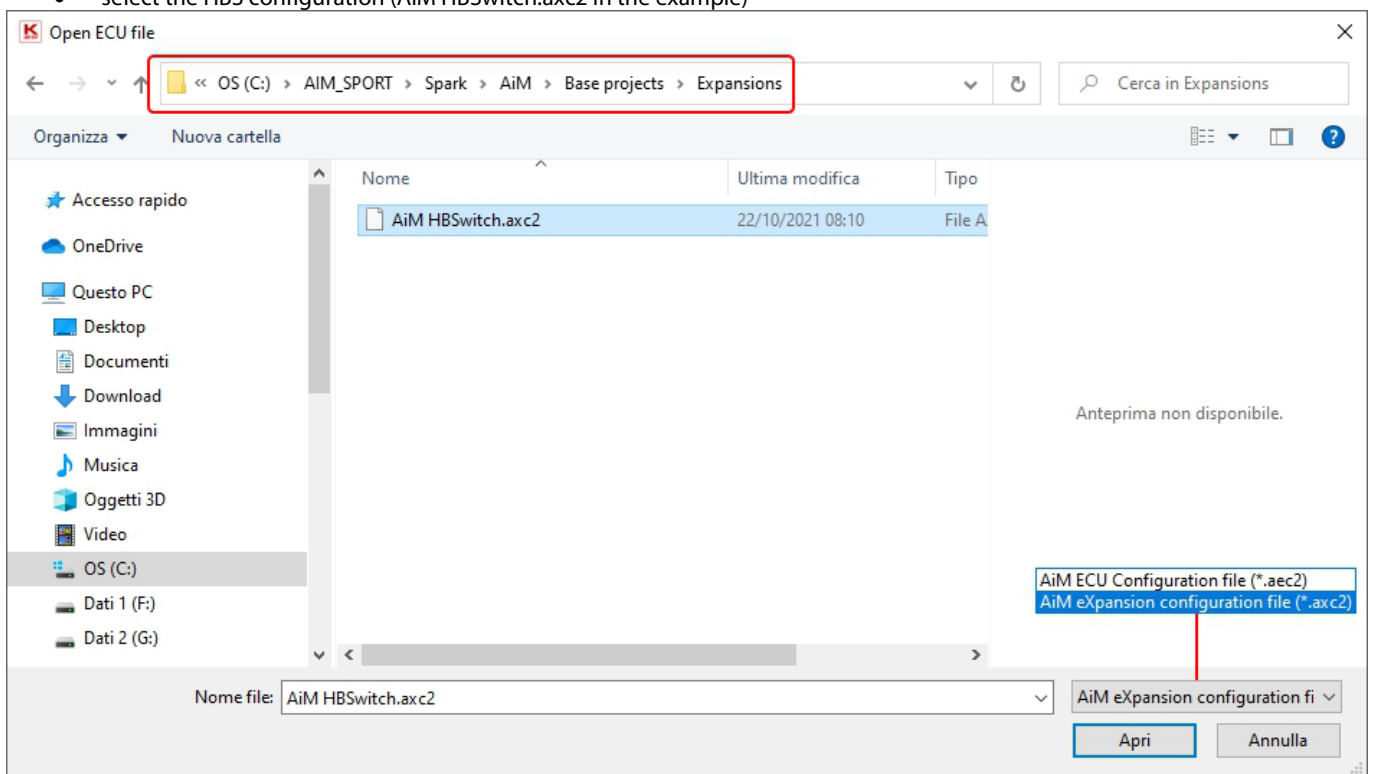

Please note: Spark software always opens "User" folder to avoid modification of default files; moreover each software update replaces "Base Projects" folder. For this reason AiM recommends to **always save your project in "User" folder.**

After the selection click “connect “Icon (in red below) – SONO STATE AGGIUNTE ALTRE ICONE O FUNZIONALITÀ?

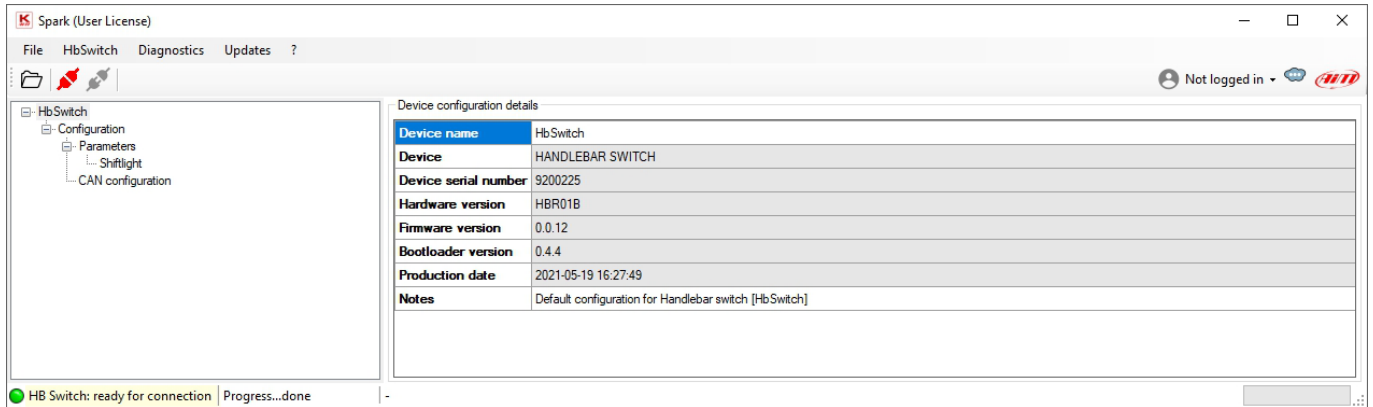

- Open the project tree left of the dialog window and select “ShiftLights” as shown here below

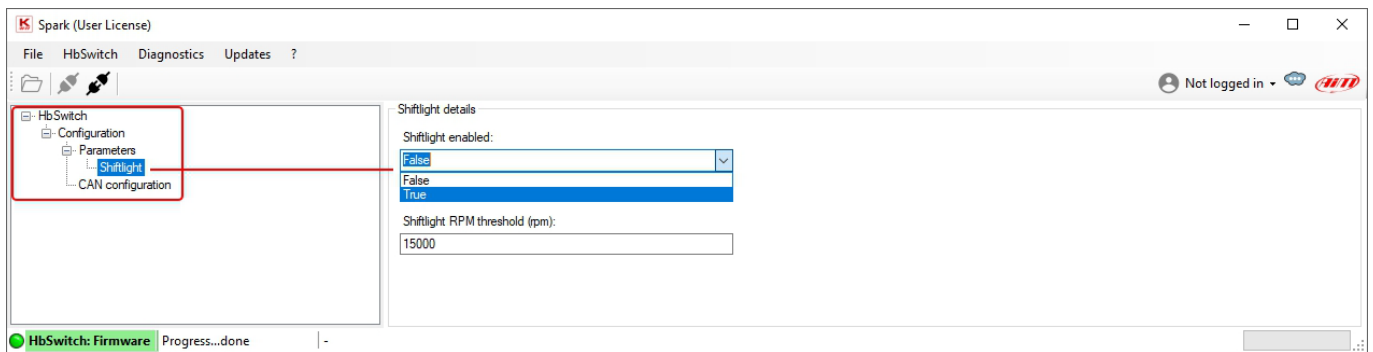

Two parameters are to be set:

- Shiftlights enabled: true if you want to use the handle switch bar as shift lights
- Shiftlight RPM threshold (RPM): fill in the RPM value that will make the LEDs flash

Please remember to connect HBS to Taipan Expansion connector to start using it.

Moreover, when HBS is connected to UC-Bridge HNS configuration can be read or written using HbSwitch Menu as shown here below.

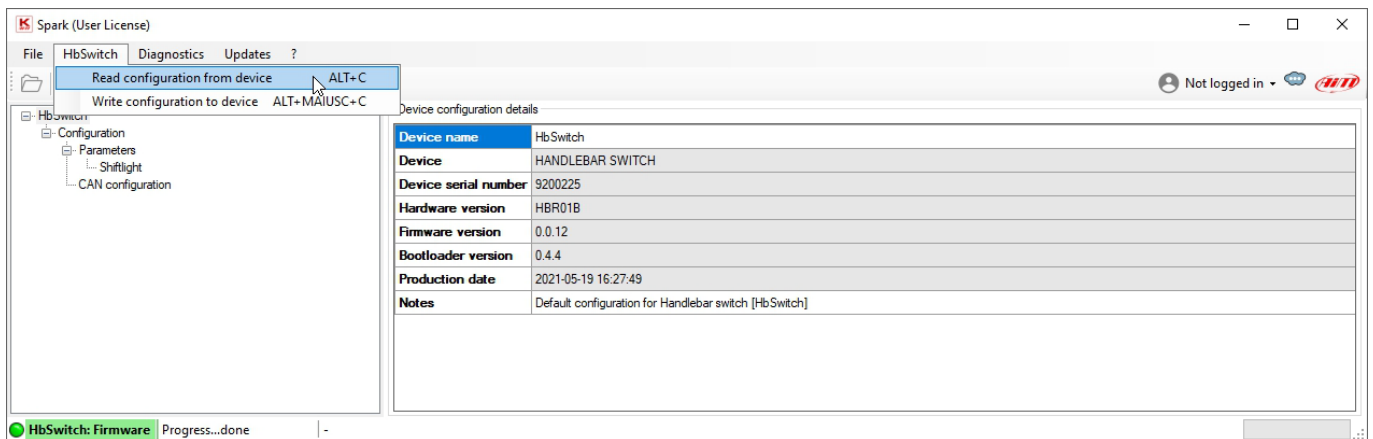

4.2 – UC Bridge

UC Bridge is the AiM device that connects Taipan CAN bus to your PC USB port and is available with 2 different licenses.

- **User license:** Taipan ECU comes with some basic maps to improve your performances. Some highly professional tuners, all over the world, offer specific maps that may better fit your requirements, managing, for example, different exhaust systems, two injector kits, etc. In this case you need UC Bridge to:
 - flash new and different maps to your ECU through an User UC Bridge
 - receive diagnostic information from Taipan ECU
- **Tuner license:** this license allows the tuner to create maps, configurations and strategies properly designed for your motorcycle. The tuner can flash the ECU directly or send the file by email, allowing the riders to download and flash their own ECU. This is done by preserving the tuners proprietary work with three layers of protection and security. This manual covers the use of the user license. Please refer to the tuner manual you find on Taipan page of www.aim-sportline.com for further information about Taipan tuner license.



5 – ECU Available configurations

Taipan ECU is available in two different configurations:

- **Blank ECU:** a Blank ECU can be configured for a specific motorcycle brand and model, simplifying the stock management of the tuners. **Please note: once a blank ECU configured for a specific motorcycle brand and model, you have 24 hours for changing this setting; after this time period you will be able to modify the maps written into your ECU but not the motorcycle brand or model for which you have configured it.** Taipans are normally shipped blank.
- **Configured ECU:** an already configured ECU for a specific motorcycle brand and model. You may change maps and configurations but cannot change brand or model motorcycle.

To know if your ECU is configured or blank run the software and press “Read ECU identity” icon on the software icon bar. The image below shows ECU Blank as shipped by AiM.

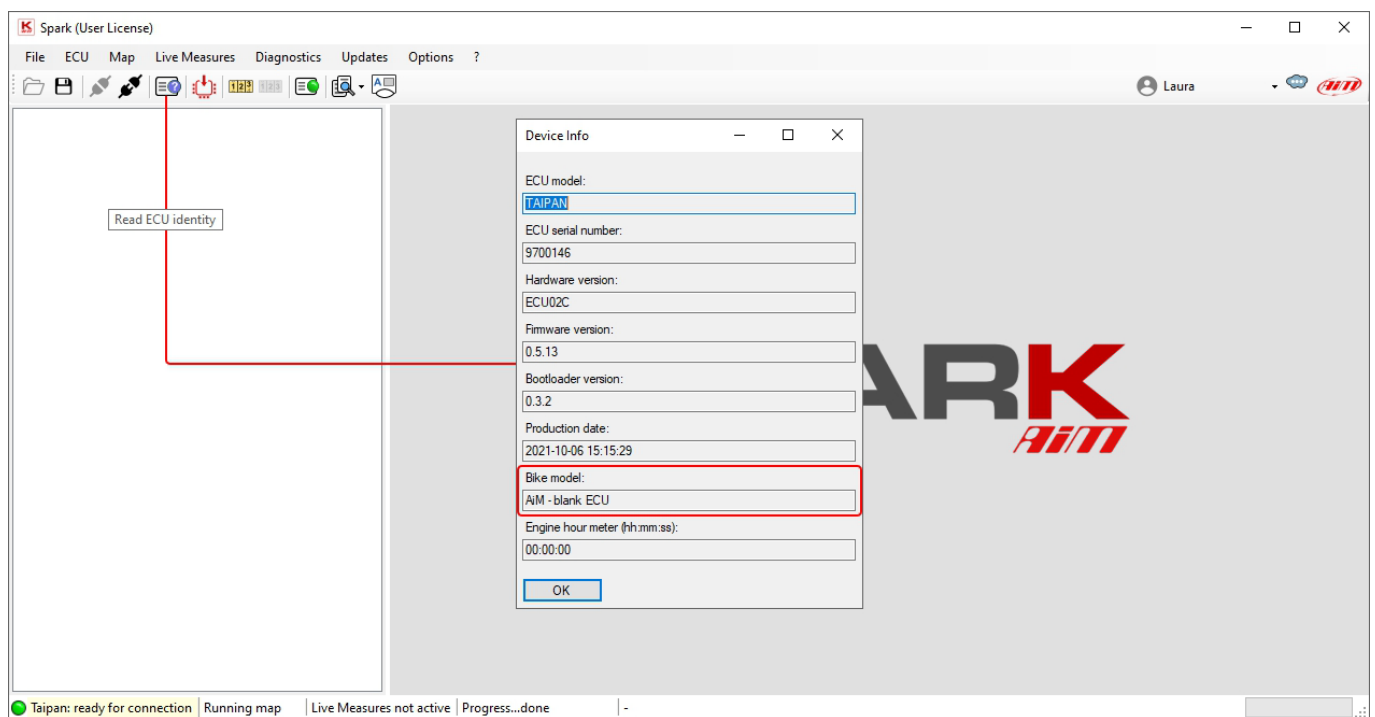

6 – Spark software user license

Spark is the AiM software used to configure and calibrate Taipan. This user manual explains all functions you can set using the software and an UC-Bridge “User” license.

Please note: to use Spark software you need to connect at least the UC-Bridge to the PC, otherwise you cannot use all features available for Spark user license. Connecting the UC Bridge and the ECU you can write and flash the ECU.

To start using Spark:

- connect UC Bridge to the PC USB port
- run the software
- connect Taipan to the software pressing the corresponding icon
- open an ECU project (File → Open ECU)
- follow this path C:\AIM_SPORT\Spark\AiM\Base projects\Ecu)
- click “Show live measures icon and a complete main window is prompted

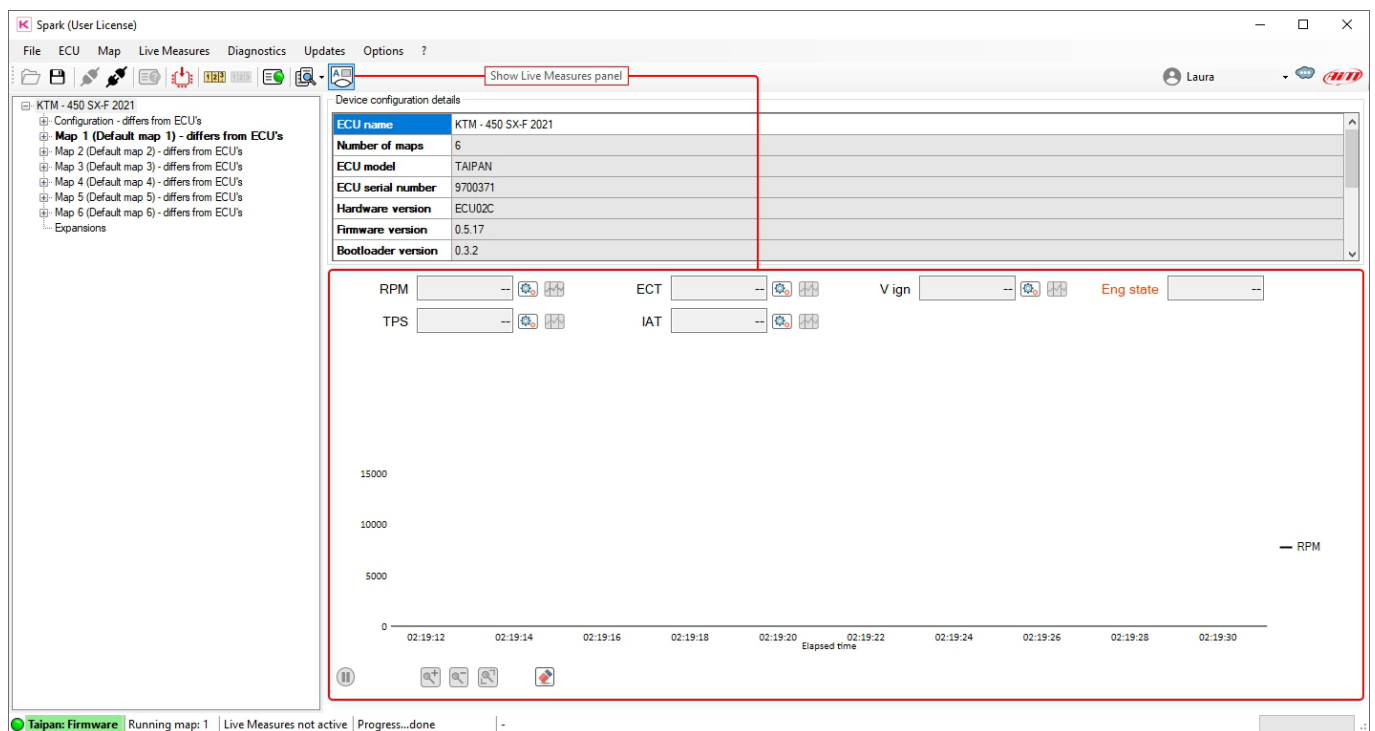

As shown here below, being the ECU blank all Live Measures boxes are empty. Moreover, if, with Taipan ECU plugged to the UC bridge and this last in turn plugged to the PC you press “connect” icon  the software connects to Taipan and prompts a warning panel.

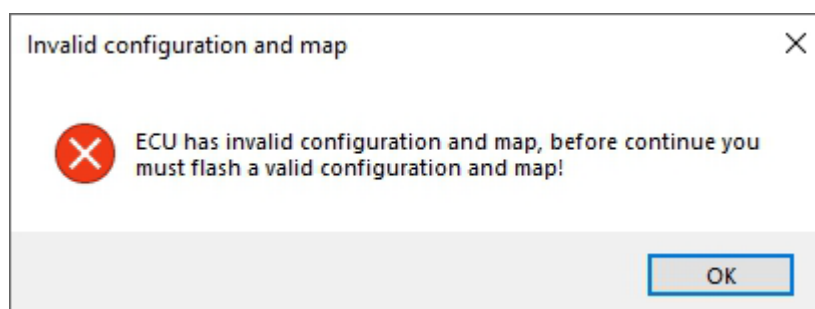

To be able to fully use spark software you need to write your bike configuration in Taipan. To do so, follow these steps.

- “File -> Open ECU project”
- ensure that the file type box bottom right of the dialog window is set on “AiM ECU Configuration file (*.aec2)”
- come back to “OS (C:)>AIM_SPORT>Spark” and follow this path “OS (C:)>AIM_SPORT>Spark>AiM>Base projects>ECU”
- enter the folder of your bike Manufacturer (“KTM” in the example)
- select your bike model (“KTM 450 SX-F 2021 AIM STD_v1.1.aec2” in the example)

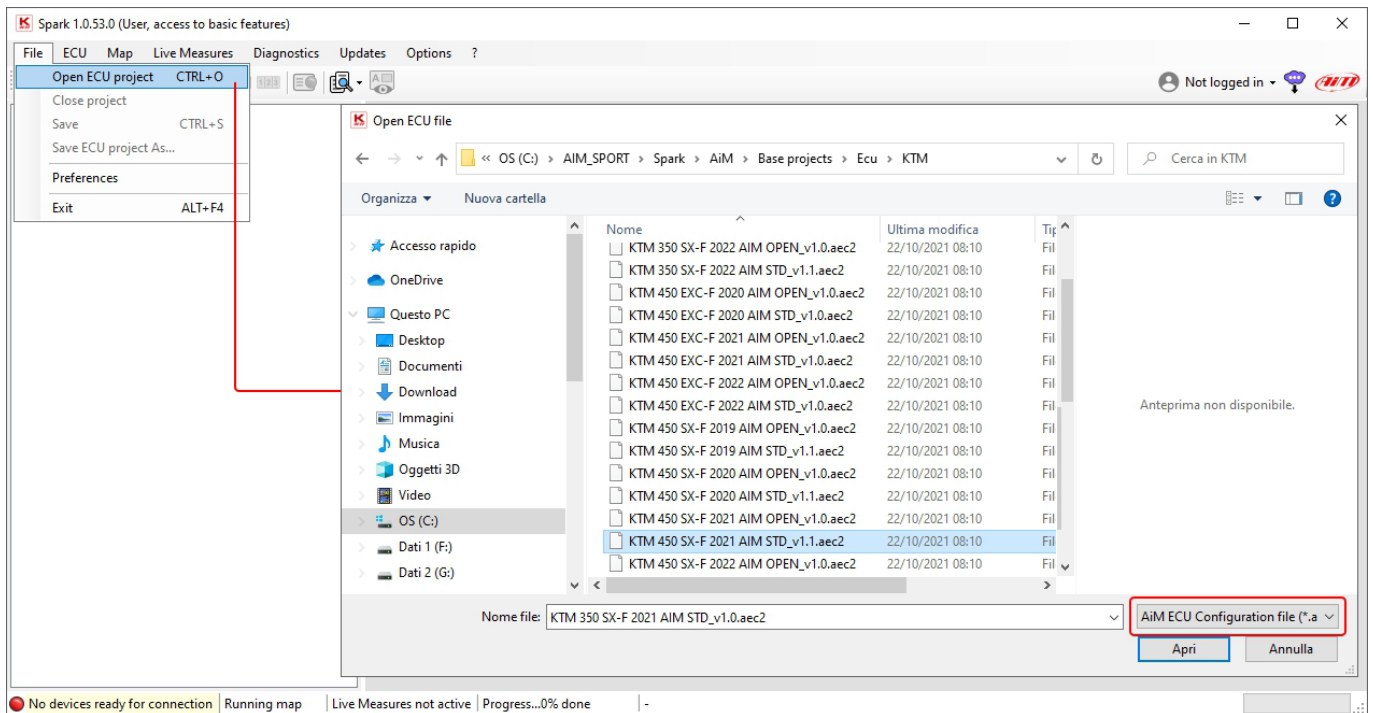

Spark software provides three types of configurations:

- **AIM OPEN:** this project file consists of six maps, all the same, of the Top performance type. Top performance is a map that allows the engine to get the best from its power delivery and performance over the entire period of use. No strategy is implemented in this project file for user. To modify configuration parameters and maps a Tuner licence and a Tuner UC Bridge is needed.
- **AIM STD (as in the example):** this project file is closed and cannot be modified or accessed by anybody, tuners included. This map can of course be send to the ECU to be used. This configuration features 6 different map types explained in the following page.
- **AIM OPEN PRO 6 FUEL:** this project file is structured in the same way as AIM OPEN file with the big difference that the map was developed using American VP Pro6 gasoline.

Once the configuration selected it is shown left of the software window with all included maps (6 in the example). They are

- **Map 1 Top Performance:** this map allows the engine to make the most of its power delivery and performance over the entire period of use. This map is developed in collaboration with the best teams and drivers in the racing world.
- **Map 2 Linear:** It is a variable of Top Performance that allows a more linear delivery of the engine power. The bike is therefore less aggressive, ensuring a much smoother and more constant throttle opening.
- **Map 3 RPM Optimizer:** with this map the power delivery of the bike remains unchanged as in Map 1 but the "over revs" is optimized. The bike, therefore, does not exceed the maximum number of revolutions of the engine but obtains a greater reach.
- **Map 4:** It is a variant of map 1 with less engine brake. The engine, therefore, maintains a racing delivery line with the not indifferent variant of a minor intervention of the engine brake during braking
- **Map 5:** It is a variant of Map 2 with less engine brake. The map therefore allows greater fluidity of use even when braking.
- **Map 6: Neutral or neutral map.** This map comes into play when the bike is in neutral and is automatically shifted. In addition to the implementation of the neutral map strategy, the following strategies are implemented: **Launch control** (with the use, where present, of the standard buttons in addition to our HBS); **Quickshift** configured the sensor as switch close to GND on spare channel 1 of the ECU.

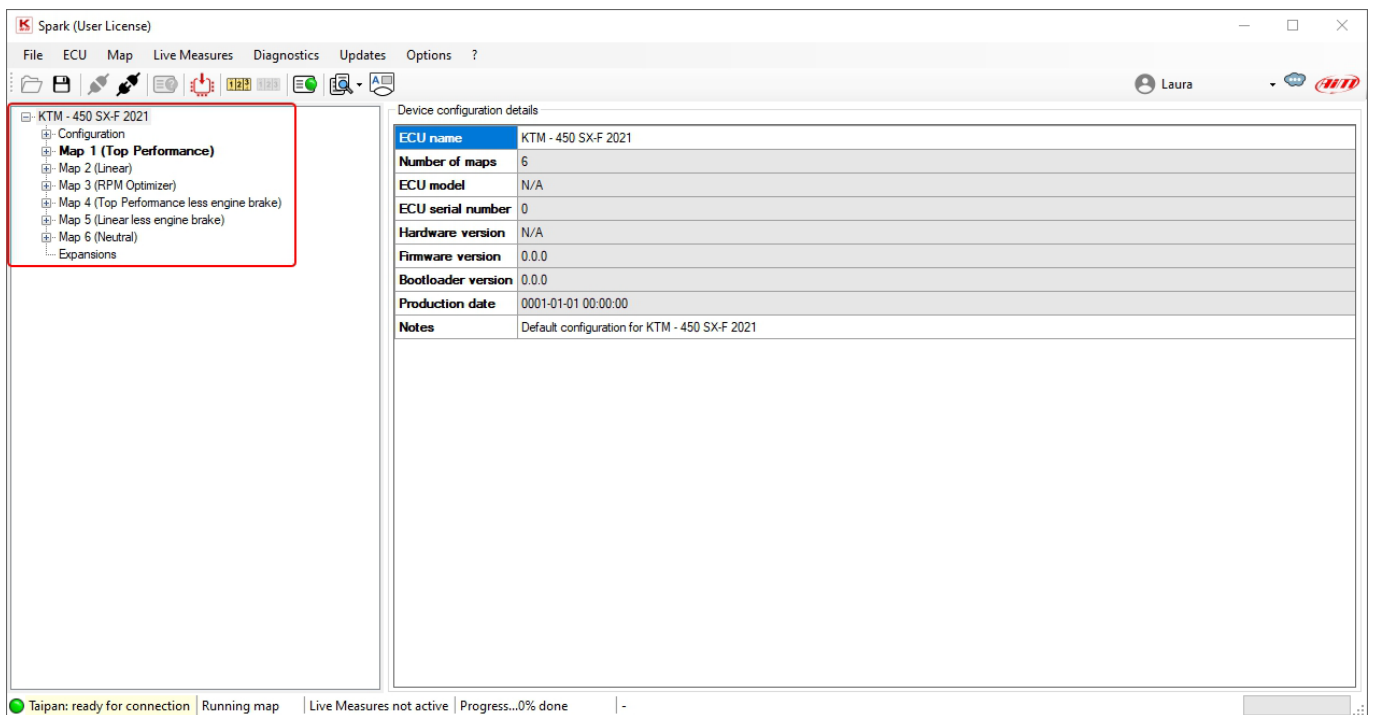



To write the map in Taipan follow this path: ECU -> Write ECU and the configuration is written in Taipan ECU

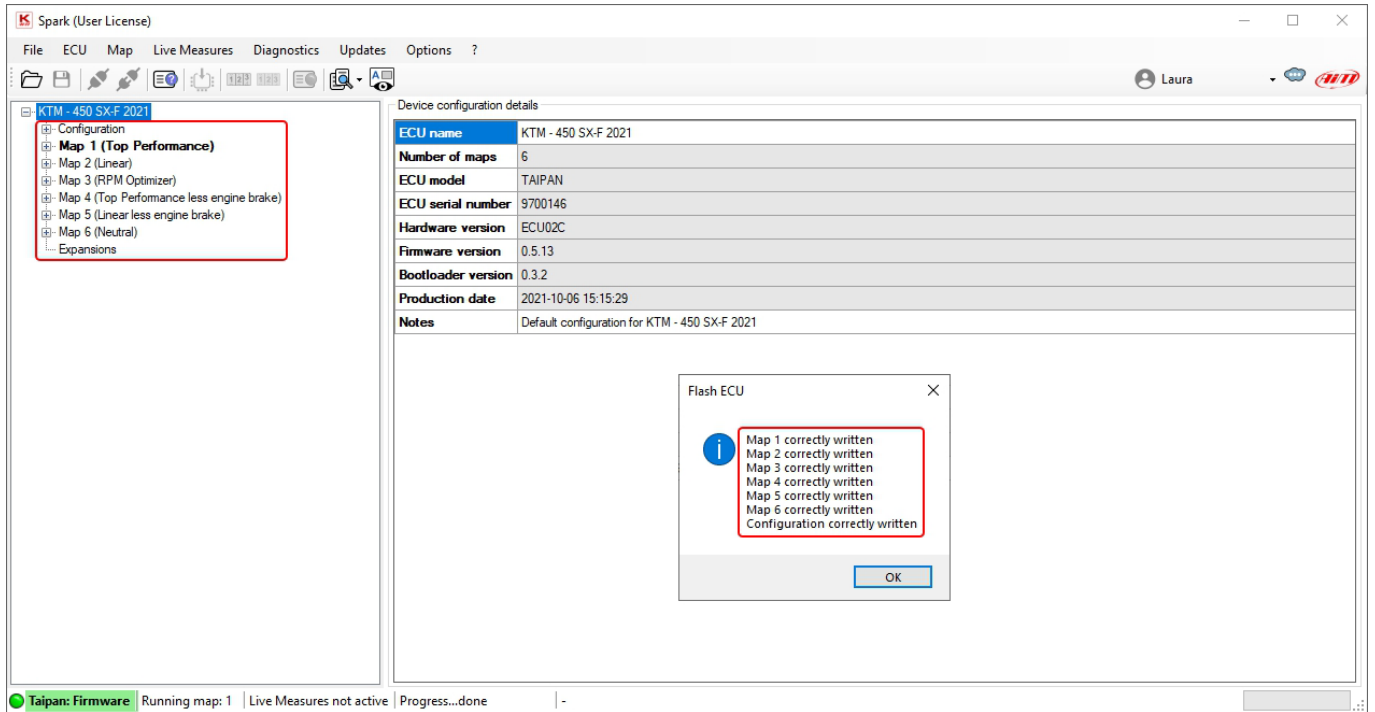

Now that Taipan is connected and has a map written in Spark software detects it.

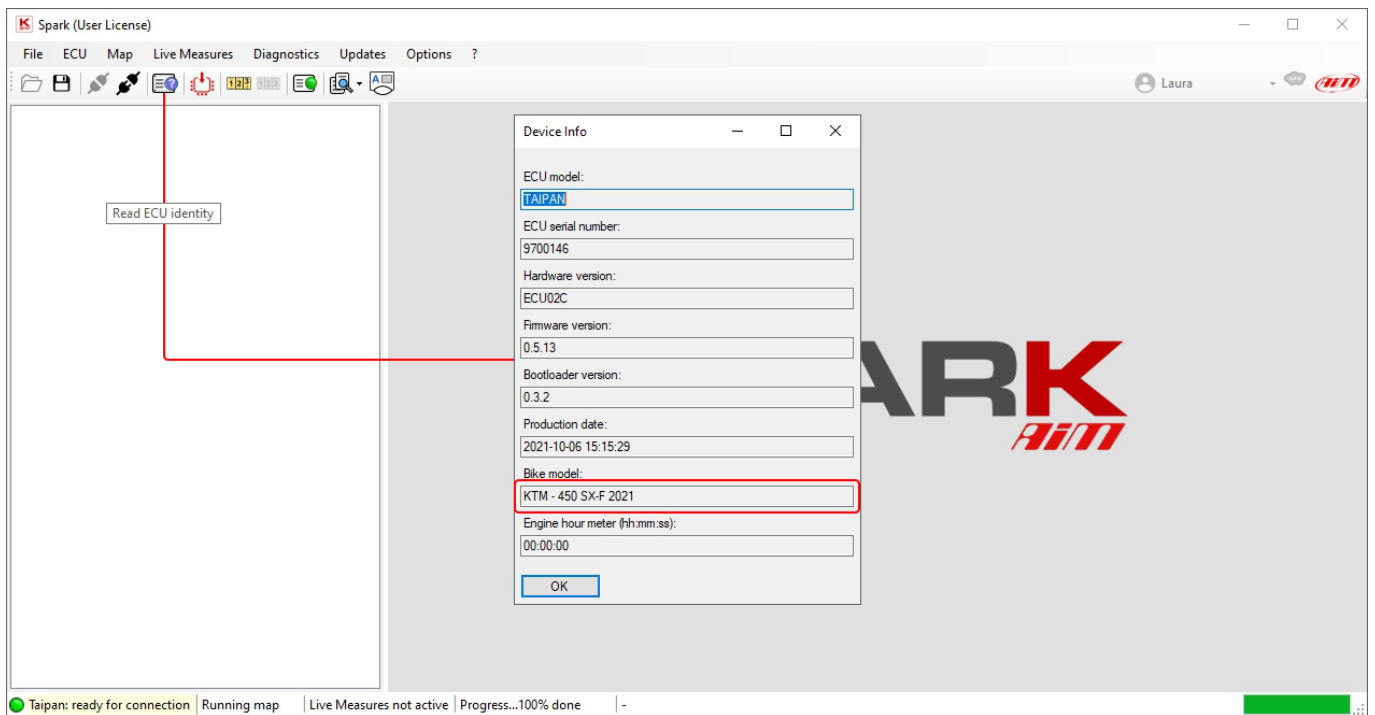

6.1 – Software overview

Here below the software window macro areas are highlighted:

- Menu bar (1)
- Icons bar (2)
- Project panel (3) with the selected map in bold
- Data panel (4)
- Live measures panel (5)
- Info bar (6)

The screenshot displays the Spark software interface for a KTM - 450 SX-F 2021. The interface is divided into several macro areas:

- Menu bar (1):** Located at the top, containing 'File', 'ECU', 'Map', 'Live Measures', 'Diagnostics', 'Updates', and 'Options ?'.
- Icons bar (2):** Located below the menu bar, containing various icons for file operations and diagnostics.
- Project panel (3):** Located on the left side, showing a tree view of the project structure. The selected map is 'Map 1 (Default map 1) - differs from ECU's'.
- Data panel (4):** Located in the top right, displaying device configuration details for the KTM - 450 SX-F 2021. The details include:

| | |
|--------------------|---------------------|
| ECU name | KTM - 450 SX-F 2021 |
| Number of maps | 6 |
| ECU model | TAIPAN |
| ECU serial number | 9700371 |
| Hardware version | ECU02C |
| Firmware version | 0.5.17 |
| Bootloader version | 0.3.2 |
- Live measures panel (5):** Located in the center, displaying real-time data for RPM (0 rpm), ECT (70.0 °C), V ign (0.056 V), TPS (0.0 %), and IAT (20.0 °C). The 'Eng state' is 'Stop'. Below the data is a graph showing RPM over time, with the y-axis ranging from 0 to 15000 and the x-axis showing elapsed time from 00:25:36 to 00:25:48.
- Info bar (6):** Located at the bottom, displaying the status of the software: 'Taipan: Firmware', 'Running map: 1', 'Live Measures active', and 'Progress...done'.

6.2 – Menu bar

Each item of menu bar opens a drop down menu. Please note that:

- “plugged” means physically connected; an ECU is plugged to the PC when plugged to the UC Bridge in turn plugged to the PC
- “connected” means that the communication between PC and ECU is activated and this is done clicking the corresponding icon



File ECU Map Live Measures Diagnostics Updates Options ?

6.2.1 – File

File Menu items are:

- **Open ECU project:** open a saved project; AiM always recommends to save your project in “User” folder to avoid modification of default files stored in “Base projects” folder and because, as said before, each software updating replaces “Base projects” folder.
- **Close project:** close the current project
- **Save:** saves the current project in a different folder to protect it from undesired overwriting
- **Save ECU project as:** save current project with a different name
- **Preferences:** sets the project measure units (see below)
- **Exit:** closes spark software

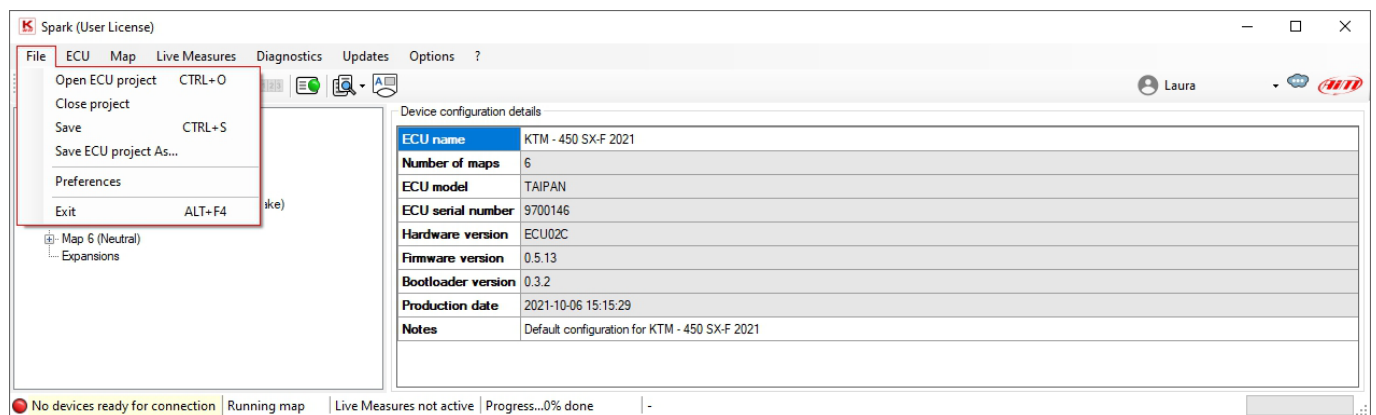

Preferences panel is shown here below.

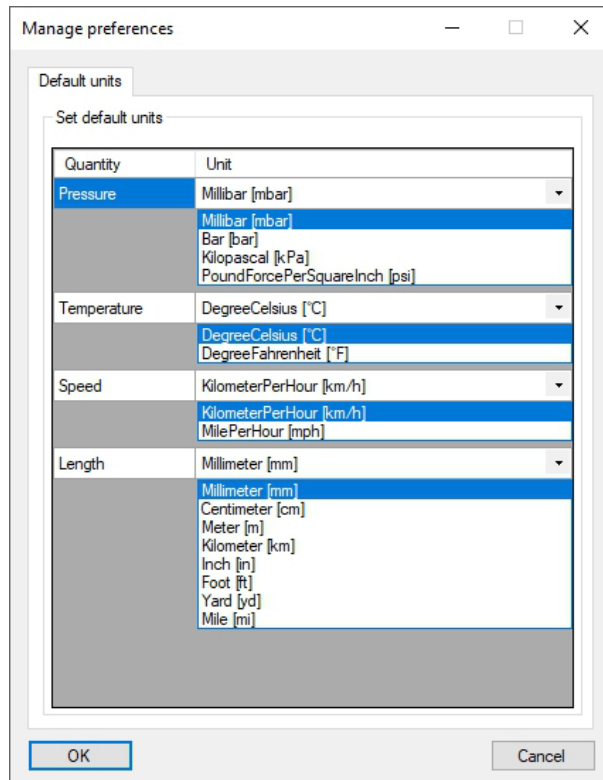

6.2.2 – ECU

Write ECU: flashes the configuration and all projects included in the project in the ECU.

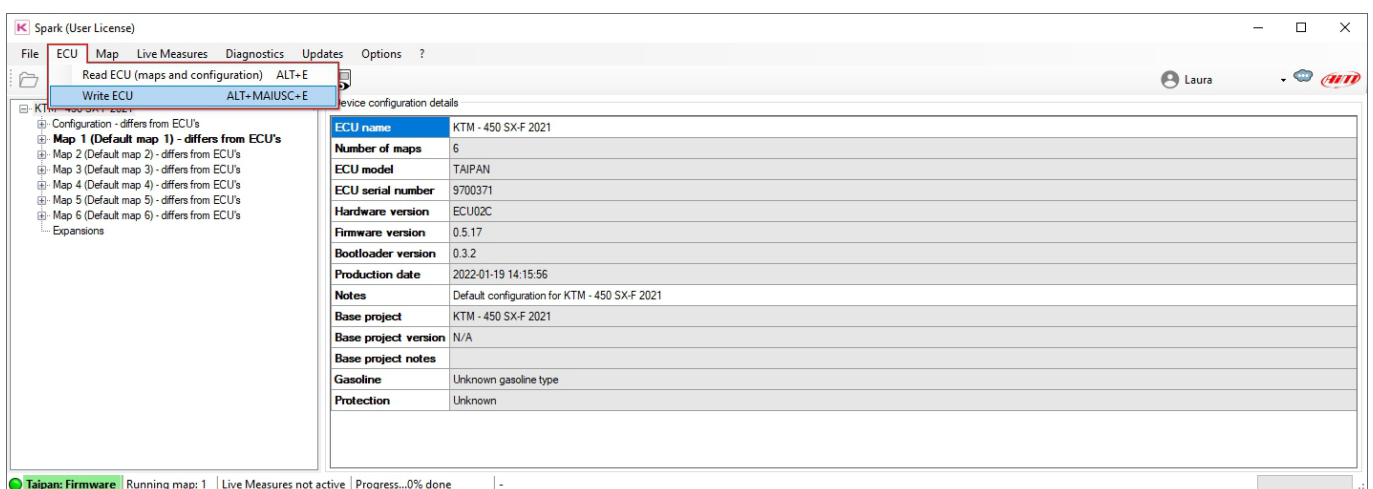

6.2.3 – Map

Allows to **change the active Map**. Follow the path “MAP -> Change active Map” and the corresponding panel is prompted. Choose the desired map in the drop down menu.

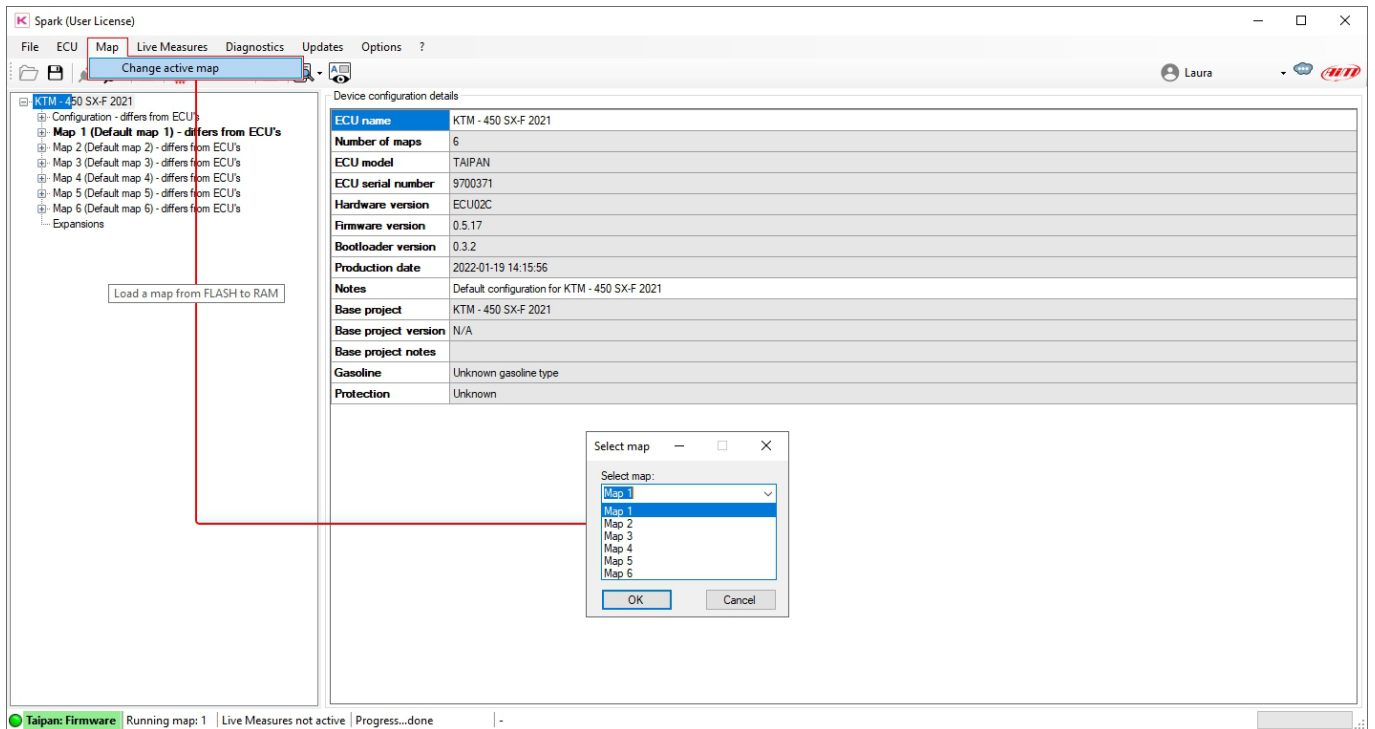

6.2.4 – Live Measures

This menu manages Taipan Live Measures.

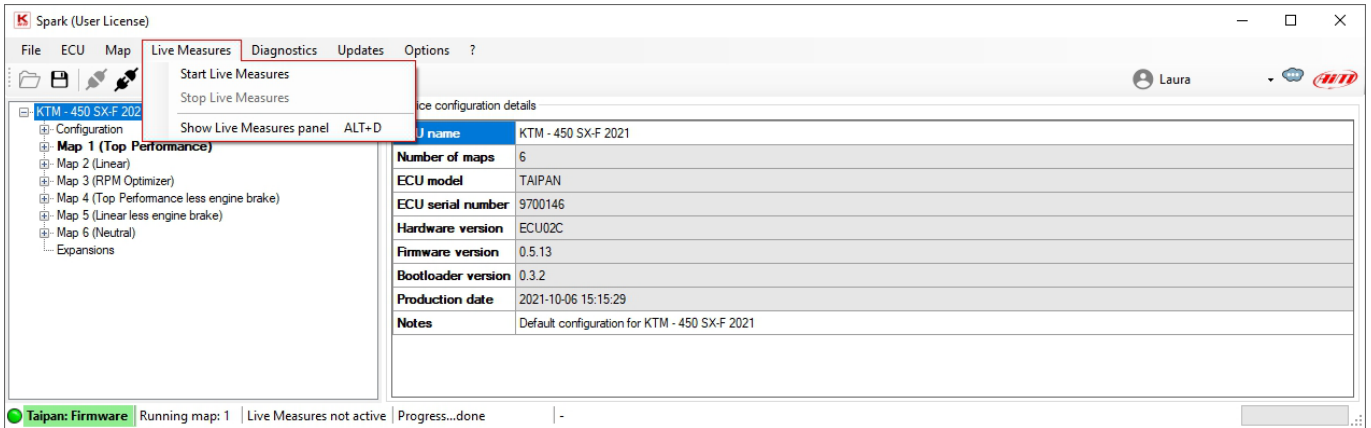

Please note: All tables can be pinned/unpinned in the software view using these icons you find top right of the software panels that allows this function (bottom panel in the image below). The panels hook/unhook from spark main window allowing the user to displace and resize it as desired, saving all functions. Once the window unhooked the icon switches to “Pin” icon indicating that if pressed the panel re-hooks to the main one.

Start Live Measures: this option to starts Live Measures once the project is opened and the ECU is connected.

Stop Live Measures: stops live measures

Show/hide Live Measures panel: these options are mutually exclusive; the first shows Live Measures box bottom of the panel (image below) and switches the menu item to “Hide Live Measures” panel.

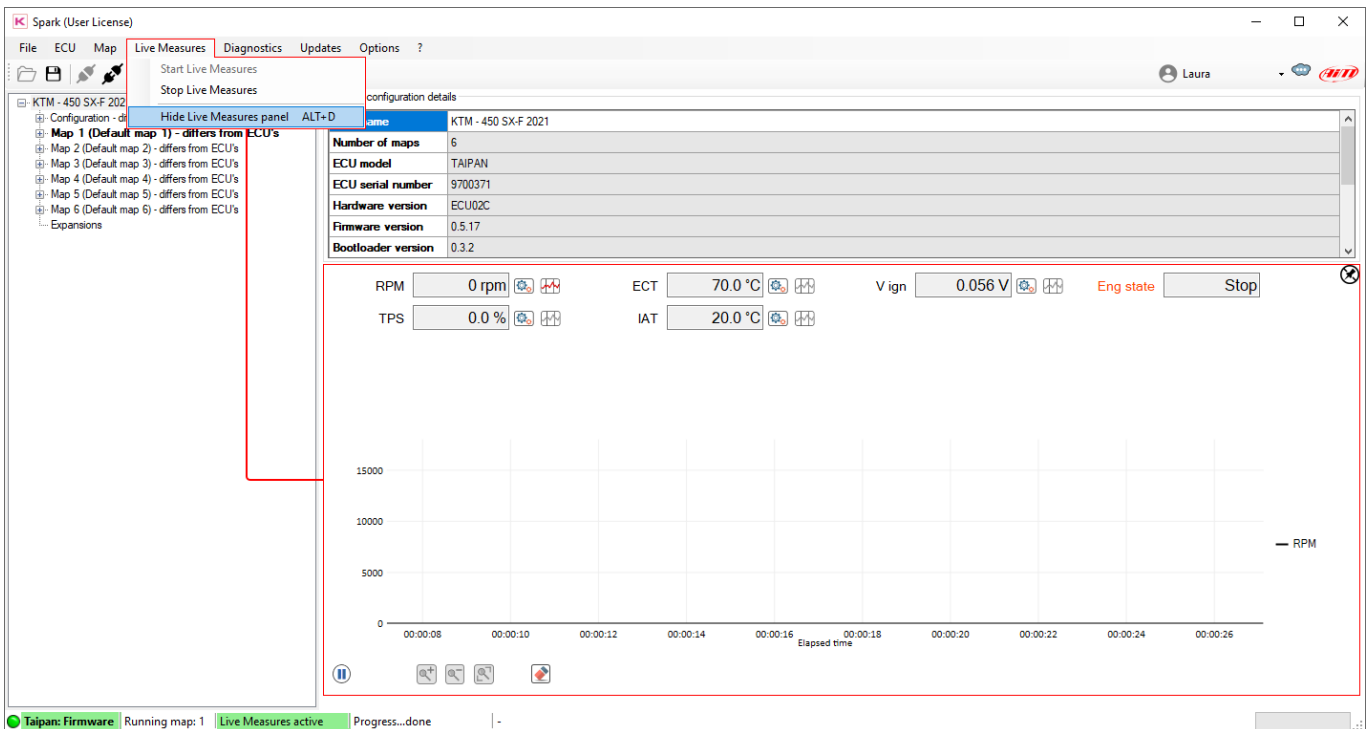

Live Measures view can be customized as preferred. The image below shows Live measures default view on top and customized view bottom. To customize the view:

- enable the graph of the channel through the proper icon (1)
- press setting button (2)
- fill in min and max values (3)
- activate colours panel (4), select the desired colour and press "OK"
- both the name of the measure and the related graph are shown bold (5)

Default setting

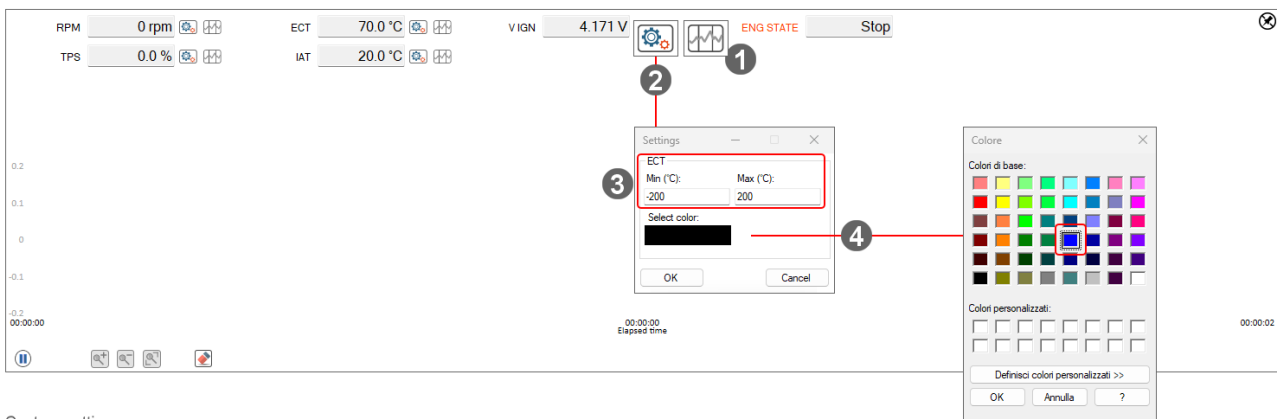

Custom setting

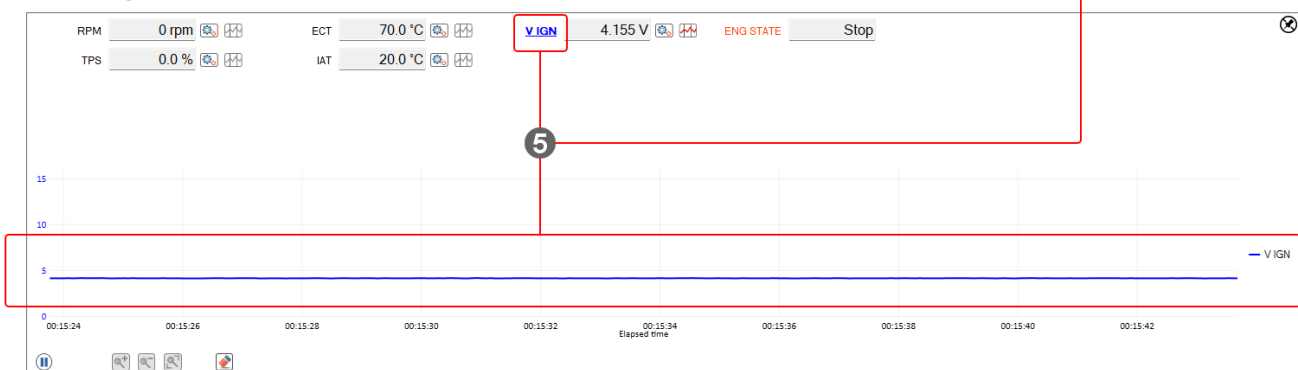

6.2.5 – Diagnostics

Diagnostics Menu allows to read the identity of all devices connected to UC Bride (one device at a time only) as well as ECU faults.



Read Freeze Fault from ECU: when the project is opened and Taipan is linked, it is possible to read the diagnostic data in real time or after a session and to check the faults of engine and sensors. Saved faults can be exported in a .csv report file or deleted. Selecting this option two tabs appear:

- Live faults tab (real time data) and
- Freeze faults tab (errors saved). Each fault is reported associated to the hour meter when it occurred.

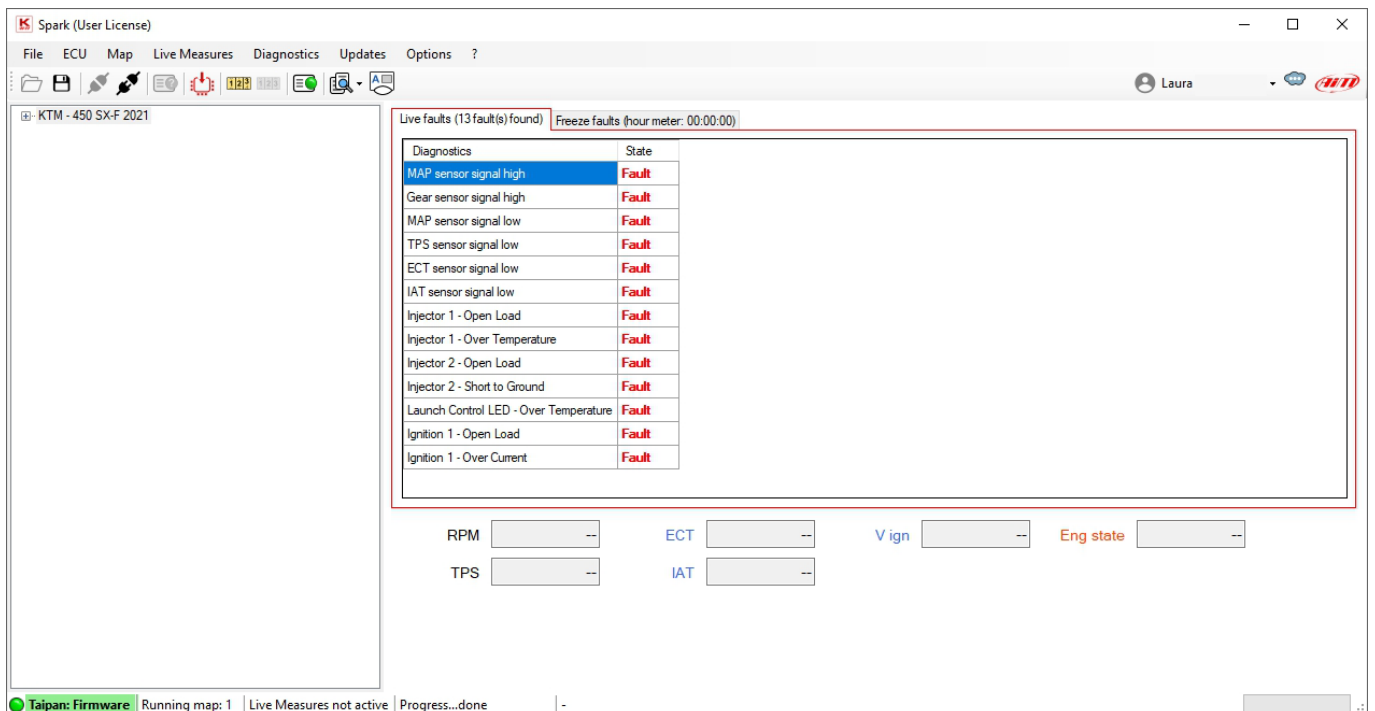
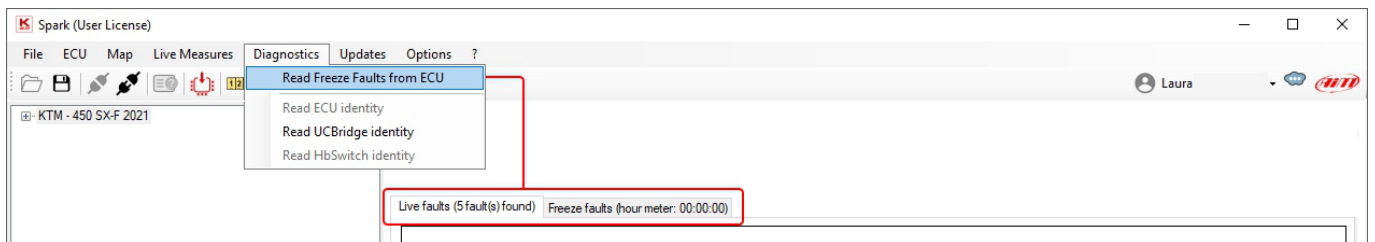

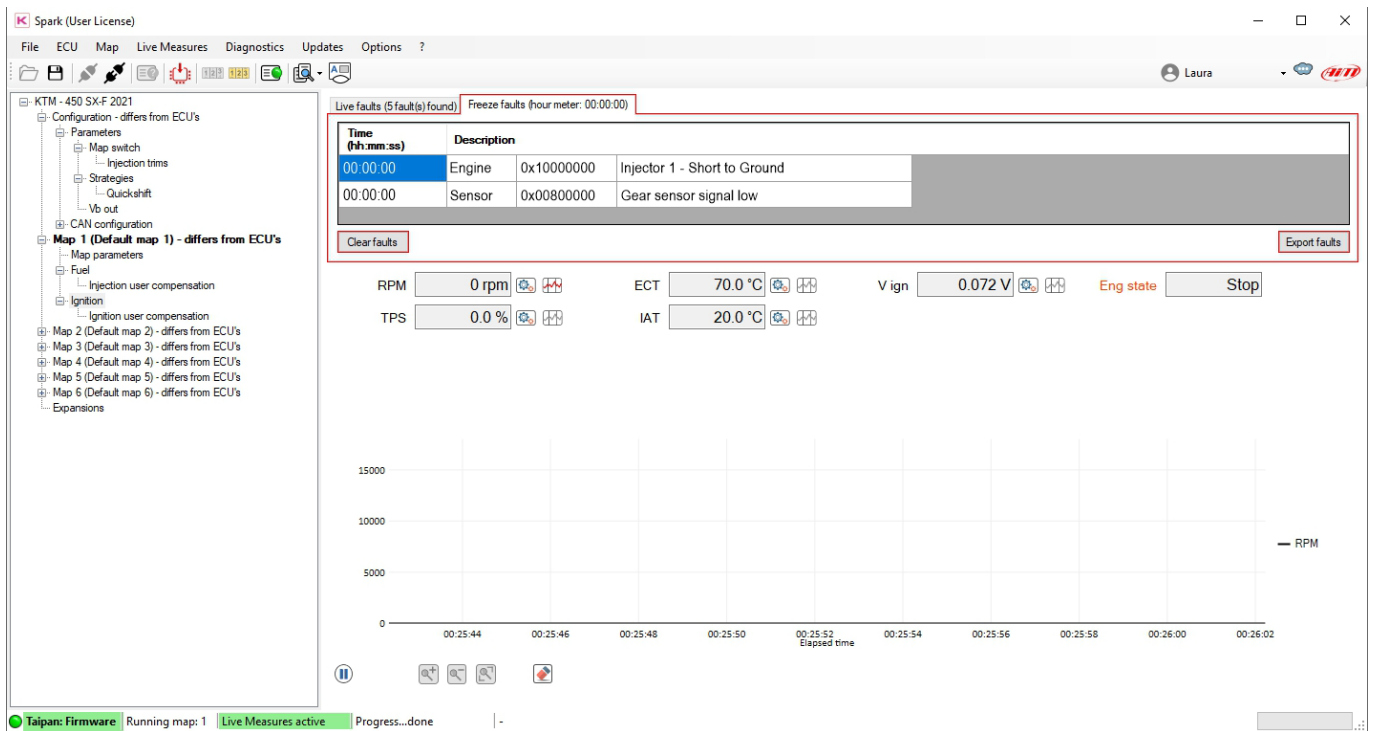

If “Live Measures” box is shown, faults can be visualized in real time. Live Measures can be activated from the proper menu (paragraph 6.2.4) or pressing the dedicated icon . Faults can be saved in a CSV file or cleared using the buttons you find bottom of “Freeze faults” layer.

The list of the possible sensor errors coming from the ECU that Spark can recognize is shown below (Injector 2 errors are present if there is injector 2 and is enabled only):

- Injector 1 - Open Load
- Injector 1 - Over Current
- Injector 1 – Over Temperature
- Injector 1 – Short to Ground
- Fuel Pump – Open Load
- Fuel Pump – Over Current
- Fuel Pump – Over temperature
- Fuel Pump – Short to ground
- Mil led – Open load
- Mil led – Over current
- Mil led – Over Temperature
- Mil led – Short to ground
- MAP sensor signal low
- MAP sensor signal high
- TPS sensor signal low
- TPS sensor signal high
- Battery voltage signal low
- Battery voltage signal high
- ECT sensor signal low
- ECT sensor signal high
- Gear sensor signal low
- Gear sensor signal high
- IAT sensor signal low
- IAT sensor signal high
- Drop sensor signal low
- Drop sensor signal high

Read ECU/UC-bridge identity: reads serial number, firmware and hardware versions of both ECU and UC bridge. This is an important info to maintain the software and devices updated.

Read Handlebar Switch identity: read serial number, firmware, and configuration from Handlebar Switch (if HB Switch is connected).

6.2.6 – Updates

This menu allows, with ECU project closed and Taipan or Handlebar switch connected to UC Bridge, to update Taipan, UC Bridge and Handlebar Switch firmware.

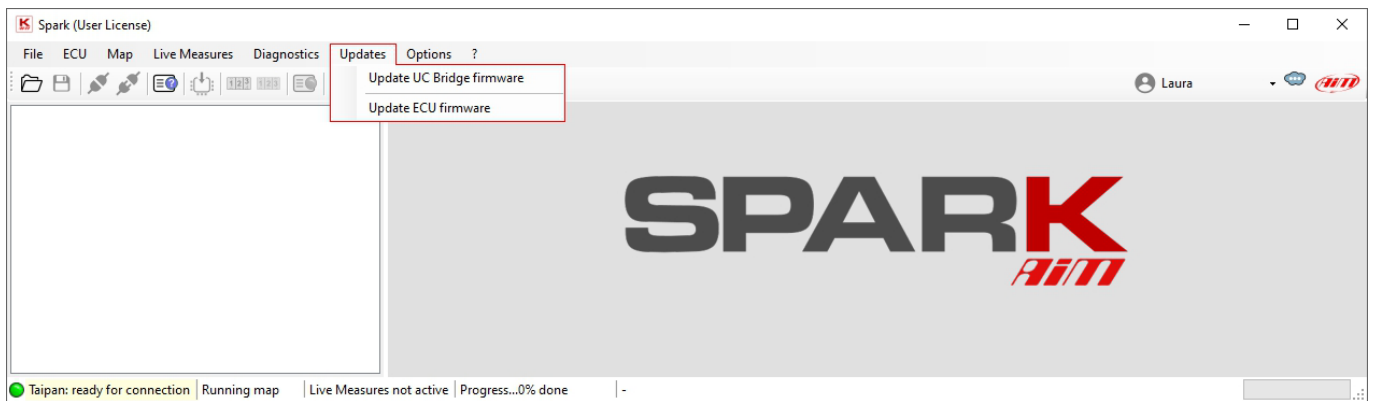

Update UC Bridge/ECU firmware: if an update is available the cloud icon right of icons bar shows an arrow ; in this case you can download and install it in this section.

Update Handlebar Switch Firmware: This section appears only if HB Switch is connected to the UC Bridge.



To update Taipan firmware and/or Spark software

- Select the firmware/software updating you need
- Press "Download" and the operation starts showing the progress bar on the right; At the end press "Install Spark" and follow the instruction prompted.

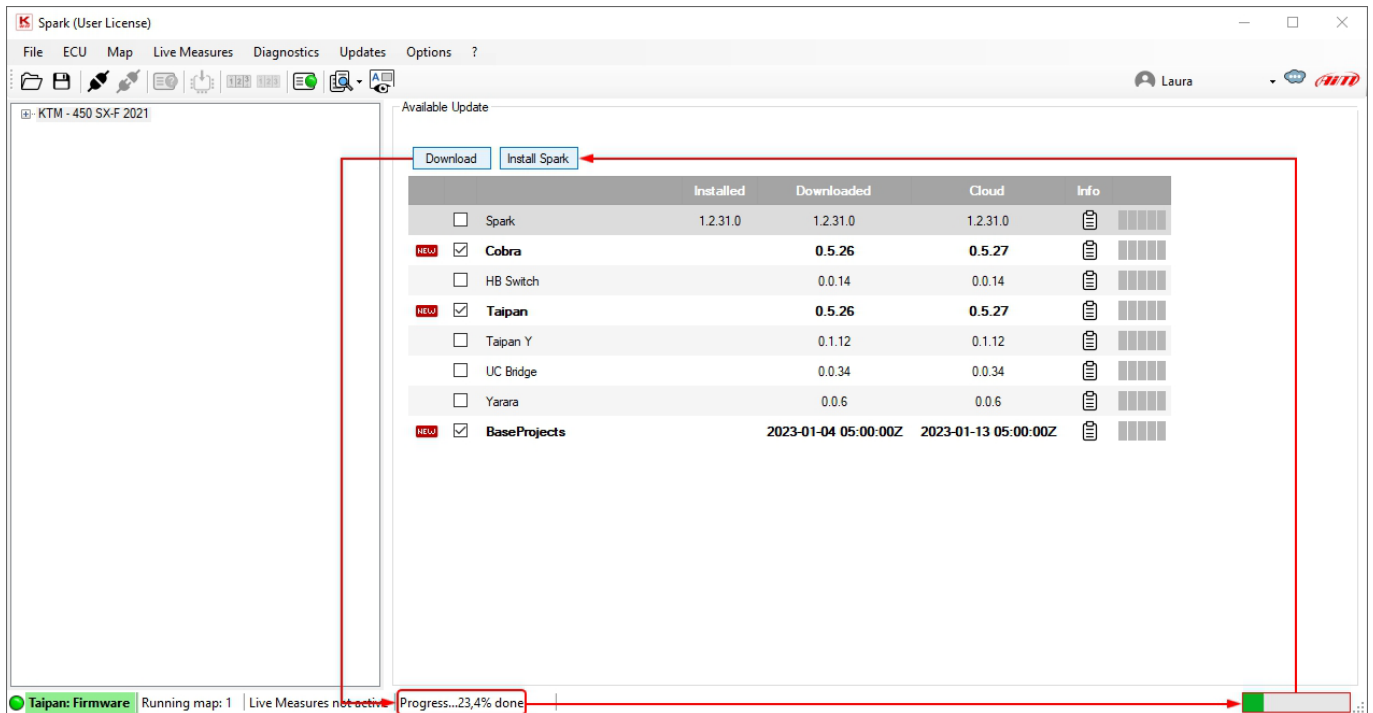

6.2.7 – Options

This bar item is to:

- TPS calibration
- IMU calibration (Taipan K only)
- Check Exhaust valve (Taipan K only)

TPS Calibration. This procedure can also be performed on the bike. This command is only available if Taipan is connected to the software and an ECU project is open. Selecting “TPS Calibration” the dedicated panel is prompted.

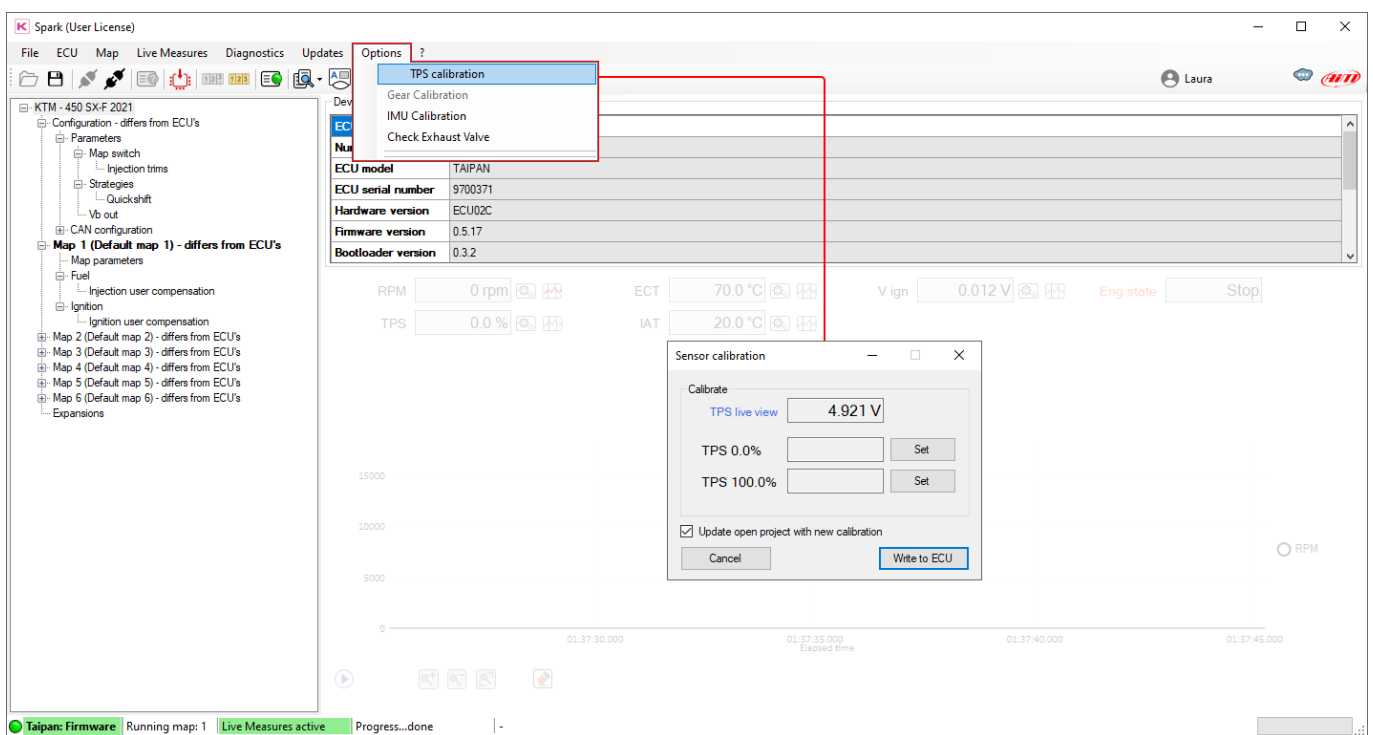

The first row shows TPS live measure expressed in volts. In order to calibrate the TPS:

- keep the throttle in its zero position (completely closed) and click “Set” in correspondence of TPS 0.0%. The value in volts, corresponding to the throttle zero position, will appear
- subsequently maintain the throttle in its 100% position (fully open) and click “Set” in correspondence of TPS 100.0%. The value in volts, corresponding to the throttle fully open position, will appear
- afterwards, clicking “Write to ECU” the TPS calibration is flashed to the ECU.

Once TPS calibrated a gauge has been added to give the user an easier feedback about TPS Value.

Please note that, if “Update open project with new calibration” checkbox (bottom left of the panel) is enabled, the TPS calibration will be updated to the open project too.

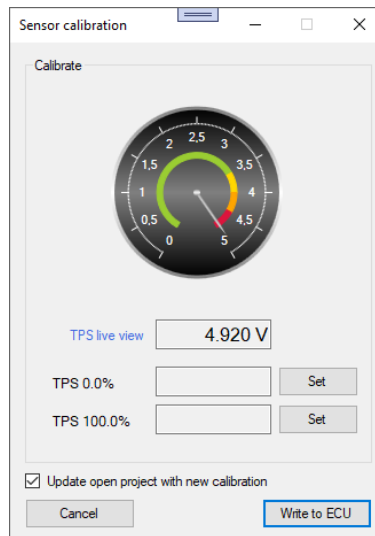

IMU Calibration (Taipan K only). IMU Calibrations is to calibrate the bike roll and pitch angle. To perform the calibration follow this path: “Options → IMU Calibration” as shown here below. The proper panel is prompted. To perform IMU calibration place the bike in its “Zero” position and press “Write to ECU”. The software stores this situation as “Zero position” for both angles.

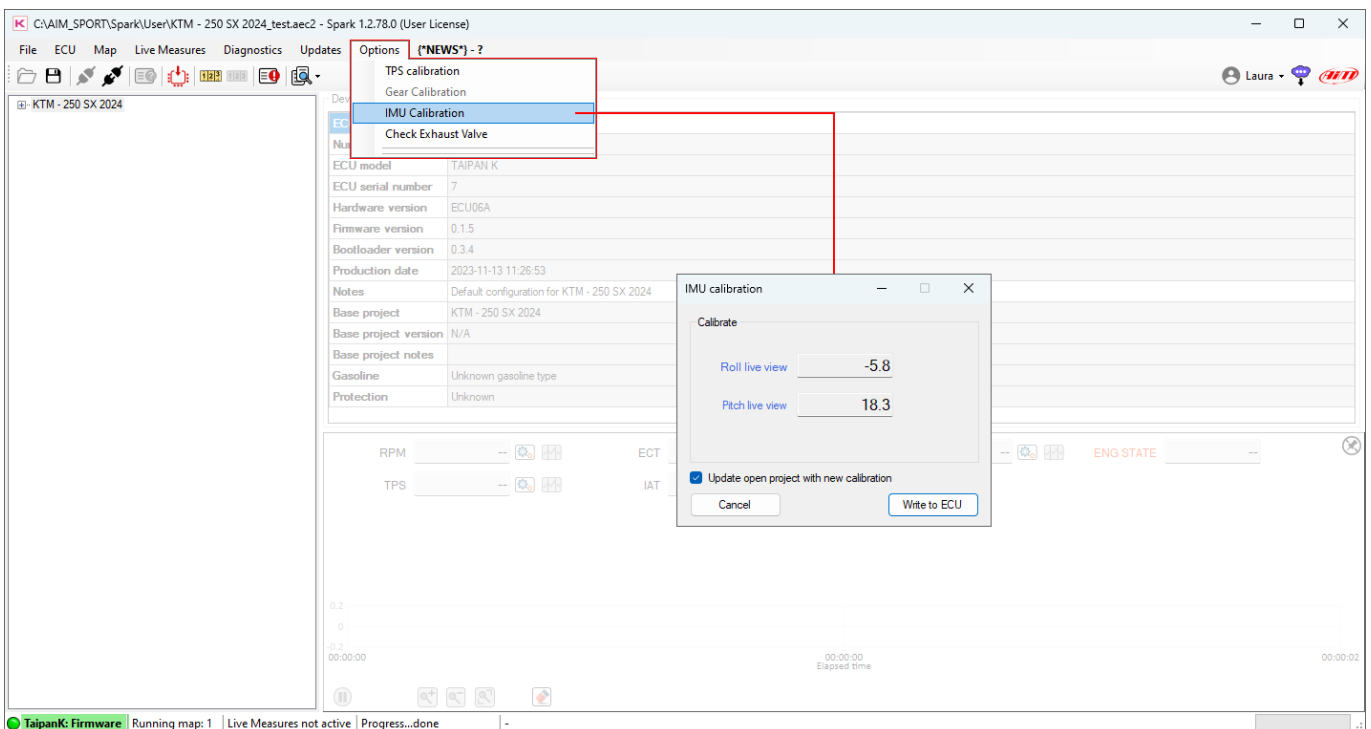

Check Exhaust Value (Taipan K only). This option is to calibrate the exhaust valve opening. To perform the calibration follow this path: "Options -> Check Exhaust value" as shown here below. The related panel below is prompted. To check the exhaust valve press "Check" and the ECU moves the valve in the three checking positions:

- 100% opening
- 50% opening
- 0% opening

Once all three positions tested the result is shown in the panel. If everything is ok it writes "Check ok" in blue; otherwise it writes "Check error" in red as shown here below.

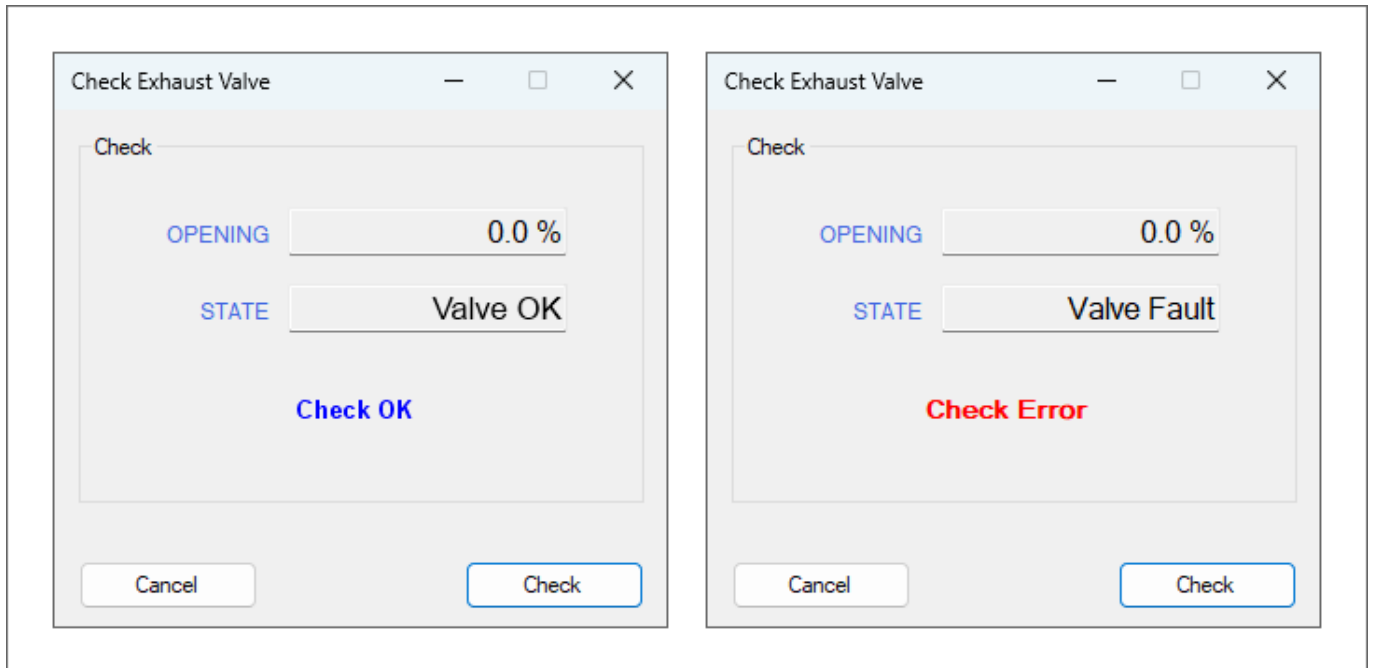

Gear Calibration gauge. In gear calibration window a gauge has been added to give the user an easier feedback about gear value (volt). To perform gear calibration follow these steps:

- Press "Option" on the top menu bar
- Select "Gear calibration" option
- A setting panel is prompted: fill the gear number and press "OK"

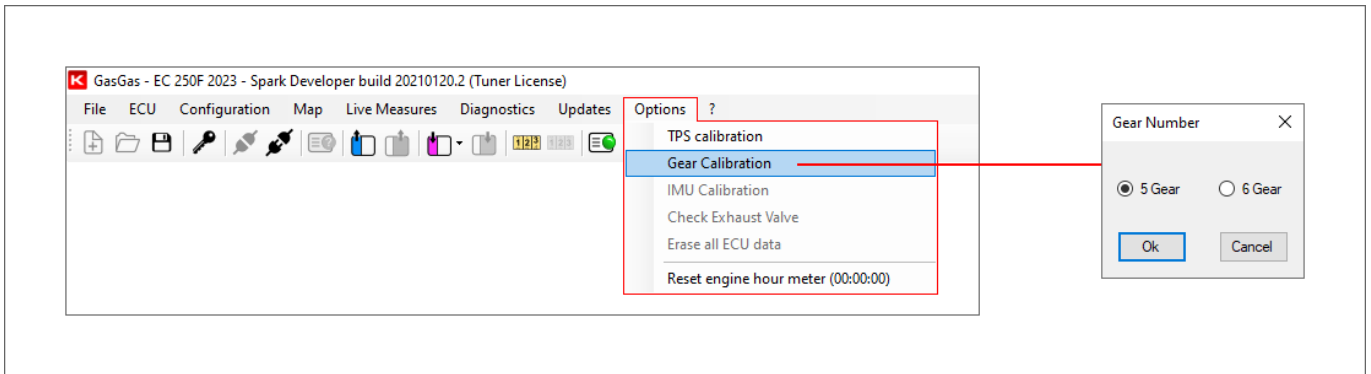

The panel with gauge shown here below gives the user a more user friendly feedback.

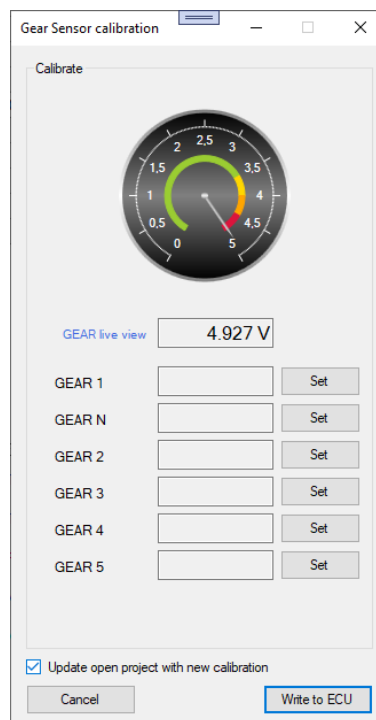

6.2.8 – What’s new

Far right on the top menu bar the additional “What’s new” menu has been introduced. It connects to an internal document that is installed with Spark and gives the user an overview of the last improvement of the software. This menu remains bold until is clicked for the first time. Once clicked, when restarting the software it disappears.

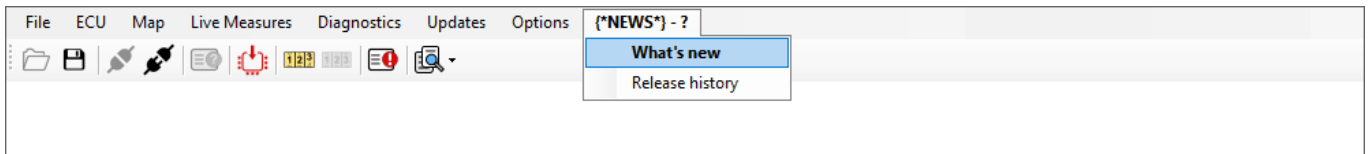





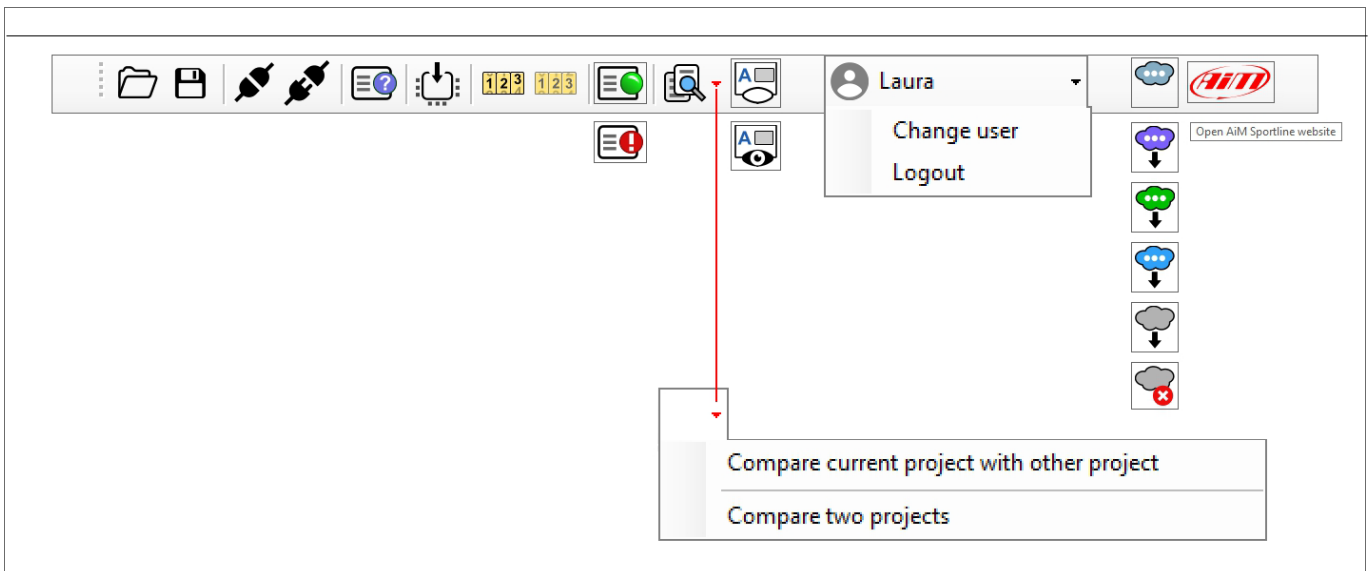













6.3 – Icons bar

This bar features some shortcut icons for the most common commands. Some of these icons are activated only if the project is open, others when the project is open and the ECU linked.



Icons vertically columned are shown in alternative according to the situation. Their meaning are here explained in the table below.

| | | | |
|---|---|---|--|
|  | Open Project. |  | Compare to compare the current project with another project as well as to compare two projects. |
|  | Save project. |  | Show live measure panel. |
|  | Link Taipan to Spark software provided that Taipan is plugged to the UC Bridge and this last plugged to the PC USB port. |  | Hide live measures panel. |
|  | Unlink Taipan from Spark software. |  | No web update available but web connection ok . |
|  | Read device identity. This command shows if Taipan is blank or configured and for which bike model is configured. |  | Web update available and web connection ok . |
|  | Write project to Taipan. |  | Web update ready for installation and web connection ok . |
|  | Start live measures. |  | Downloading web updates and web connection ok . |
|  | Stop Live measures. |  | Web update available but web connection not detected . |
|  | No diagnostic fault detected. |  | No Web update available no connection detected . |
|  | Diagnostic fault detected. With live measures active only. | | |

To compare different project you need to select the desired comparison and then fill in the related panels as shown here below.

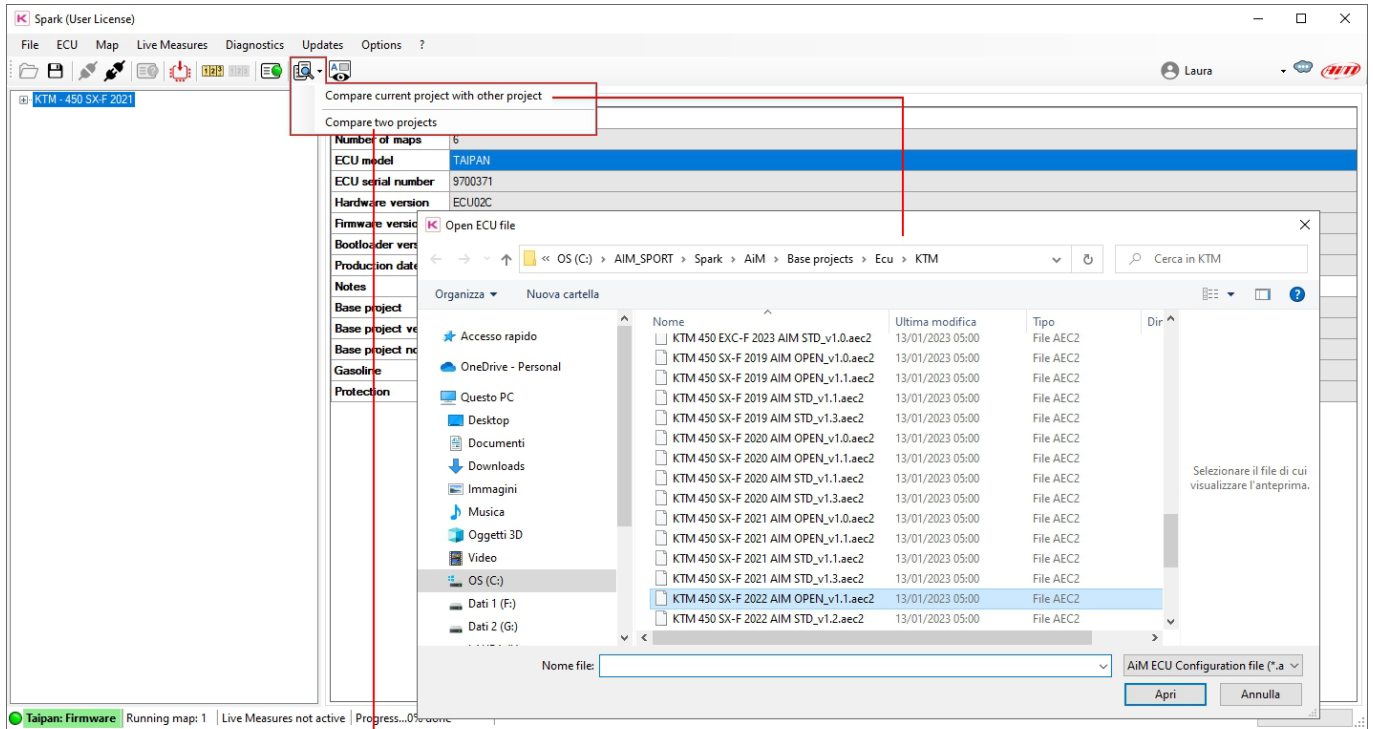



Once the maps selected a comparison panel is prompted as shown here below.

The screenshot shows a software window titled "Compare - KTM - 450 SX-F 2021 vs KTM - 250 EXC-F 2022". On the left is a tree view of configuration parameters. The right pane shows a comparison table between two configurations: "KTM - 450 SX-F 2021 (Project configuration)" and "KTM - 250 EXC-F 2022 (Project configuration)". A red box highlights the "Map switch.Injection trims.Default.Low to mid RPM threshold (rpm)" row, showing values of "4000\6000" for the first configuration and "8000\10000" for the second.

| Parameter | KTM - 450 SX-F 2021 (Project configuration) | KTM - 250 EXC-F 2022 (Project configuration) |
|---|---|--|
| Map switch.Injection trims.Default.Trim injection correction step percentage for low RPM (%) | 5.0 | 5.0 |
| Map switch.Injection trims.Default.Trim injection correction step percentage for high RPM (%) | 5.0 | 3 |
| Map switch.Injection trims.Default.Mid RPM trim | 3 | 3 |
| Map switch.Injection trims.Default.Low to mid RPM threshold (rpm) | 4000\6000 | 8000\10000 |

6.4 – Project panel

The **Project** panel you find top left of the software view shows all the maps included in a configuration. Once a project opened or created, the software shows the image below. In the Project tree view the software shows the default project panel (left image below):

- Motorcycle model (KTM – 450SX-F – 2021 in the example on the right)
- Configuration
- Configuration Maps (6 in the example on the right)
- Expansion: the Handlebar Switch and related parameters

Opening the three clicking on the “+” icon left of the project panel you see some additional items:

- Parameters
 - Map Switch/Injection trims
 - Strategies/Quickshift
 - Vb out
- CAN Configuration/CAN parameters

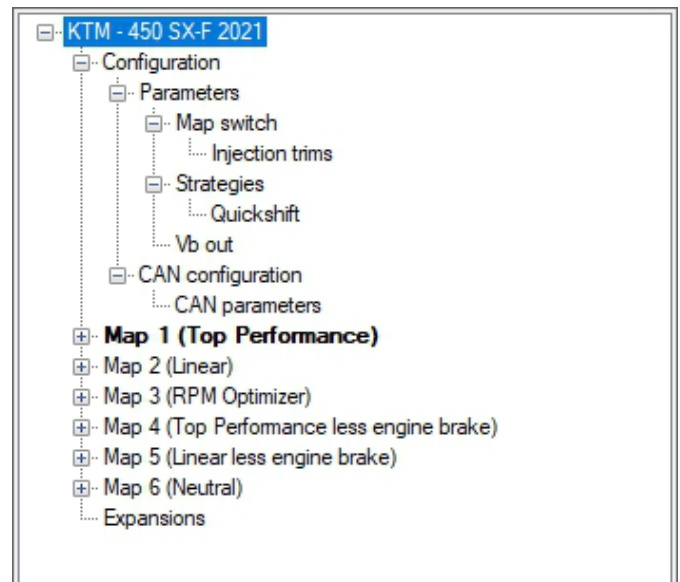
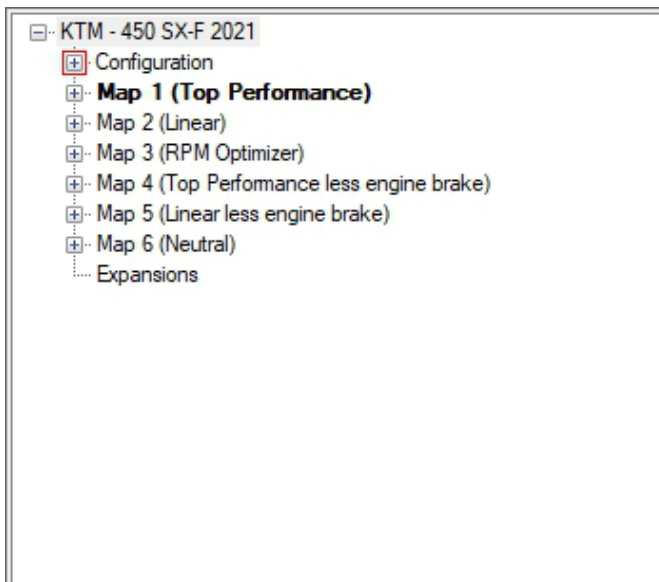



Pressing “Connect” icon  the right part of the software view shows “Device configuration details”:

- ECU Name: Taipan takes the name of the configuration you have flashed (KTM – 450 SX-F 2021 in the example below)
- Number of maps: is the number of maps included in the configuration (6 in the example below)
- ECU Model: Taipan/Taipan Y (Taipan in the example below)
- Ecu Serial number (9700371 in the example)
- Hardware version: Taipan board code ECU02C in the example
- Firmware version: 0.5.17 in the example
- Bootloader version: 0.3.2 in the example
- Production date: when the ECU has been produced January the 19th 2022 at 14.15.56 (2.15.56 pm) in the example
- Notes: here you can see if the configuration flashed is a default one as in the example (Default configuration for KTM – 450 SX-F 2021 below) or a custom configuration
- Base project: KTM – 450 SX-F 2021
- Base project version: N/A
- Base projects notes
- Gasoline: unknowns gasoline type
- Protection: Unknown

| Device configuration details | |
|------------------------------|---|
| ECU name | KTM - 450 SX-F 2021 |
| Number of maps | 6 |
| ECU model | TAIPAN |
| ECU serial number | 9700371 |
| Hardware version | ECU02C |
| Firmware version | 0.5.17 |
| Bootloader version | 0.3.2 |
| Production date | 2022-01-19 14:15:56 |
| Notes | Default configuration for KTM - 450 SX-F 2021 |
| Base project | KTM - 450 SX-F 2021 |
| Base project version | N/A |
| Base project notes | |
| Gasoline | Unknown gasoline type |
| Protection | Unknown |

6.4.1 – Map Switch/Injection Trims

In this section you can set percentage steps, level and ranges of fuel corrections that will be set by the Handlebar Switch. The available levels are from 1 to 5. If, for example, you set all the step percentages to 2%:

- at Trim injector correction 3, there will be no correction because this is default value
- to have +2% correction you need to set 4 and to have 4% correction you need to set 5
- to have -2% correction you need to set 2 and to have 4% correction you need to set 1

Finally, the thresholds between Low and Mid RPM and between Mid and High RPM are set in the dedicated fields.

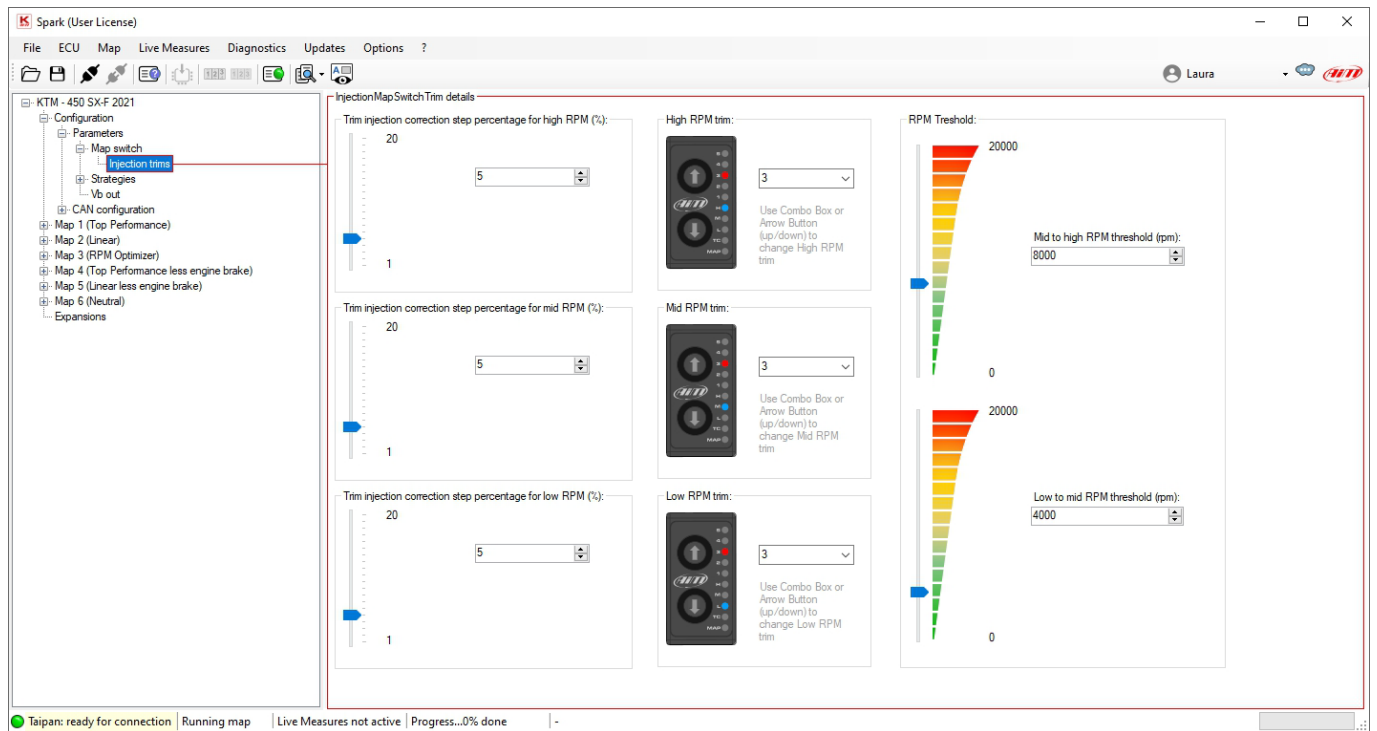

6.4.2 – Speed and gear settings (Yarara only)

For those who own a Yarara ECU it is possible to configure these parameters to have the strategies of speed and gear calculation properly working. The user should enter the circumference of the rear wheel of the ATV and the secondary ratio which is the pinion-crown ratio.

The screenshot displays the Spark software interface for configuring a Yamaha YFZ 450 2022. The left sidebar shows a tree view with 'Speed and gears settings' selected. The right panel, titled 'Speed and gears settings details', contains two input fields: 'Wheel circumference (mm):' with the value 1394, and 'Secondary gear ratio (#):' with the value 2.714.

| Parameter | Value |
|---------------------------|-------|
| Wheel circumference (mm): | 1394 |
| Secondary gear ratio (#): | 2.714 |

6.4.2 – Strategies/Quick shift

Here you can only see if Taipan Quickshift strategy is enabled or not and how.
The Quickshift may be:

- DISABLED
- ENABLED with ignition cut only
- ENABLED with injection cut only
- ENABLED with ignition and injection cut (as in the example below on the right).

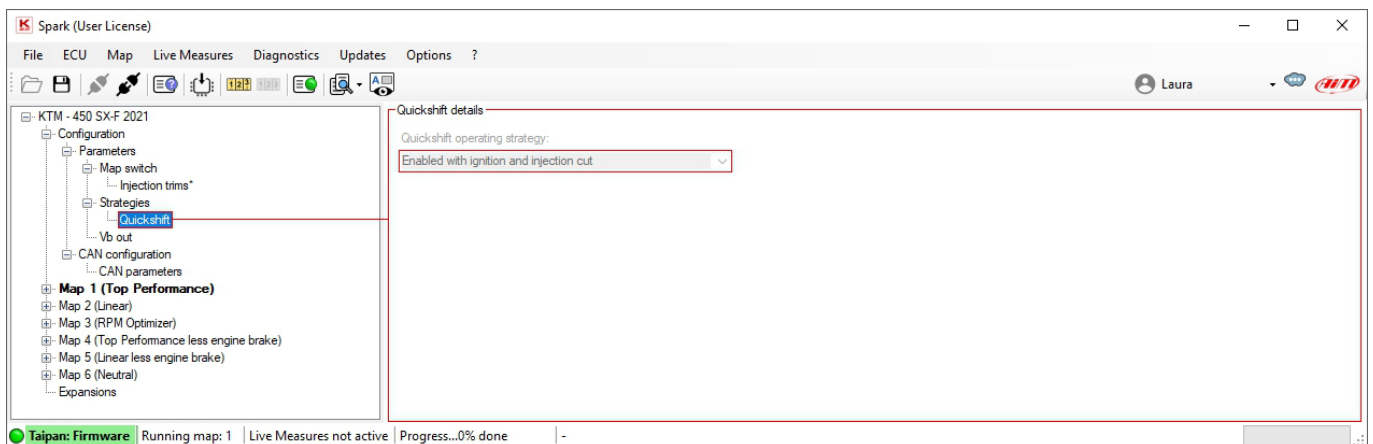

6.4.3 – Vb out

Taipan can be enabled to generate the Vb (12V power supply) in order to power an external device (i.e., datalogger). Vb out options are:

- Vb out enabled: False/True
- Vb out delay time(s) since engine phased: Vb out is generated only if the engine is running and is phased. If these conditions are met, once the delay time expires the ECU starts supplying power externally.

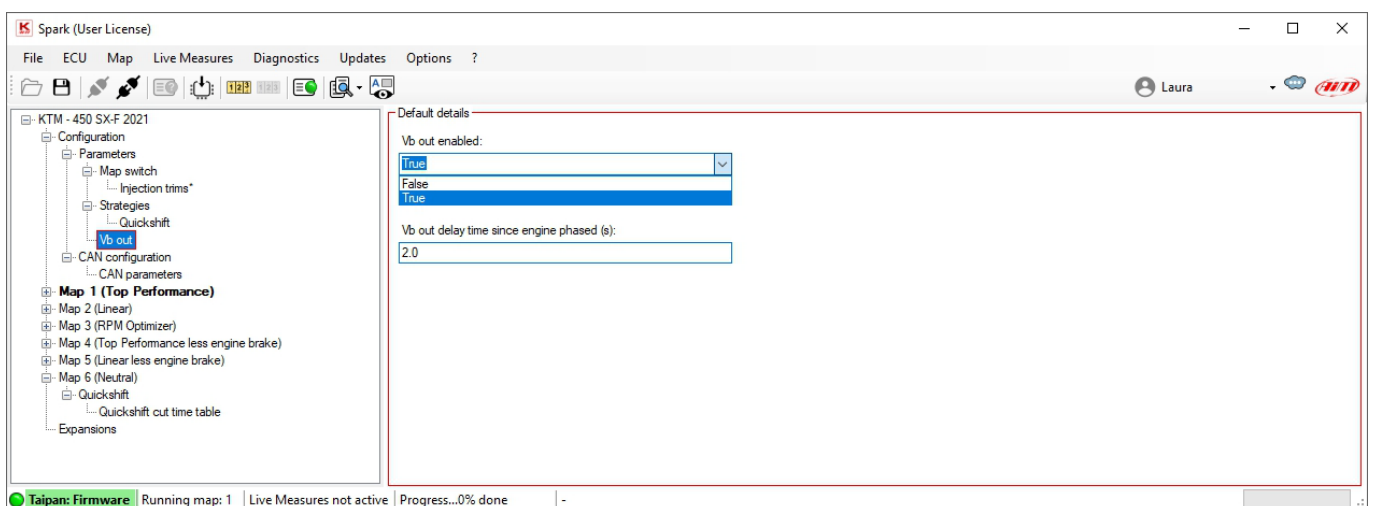

6.4.4 – CAN Configuration/CAN parameters

To modify this section you need to set “Expansions,” the last section of the project three, on “False” as shown here below”.

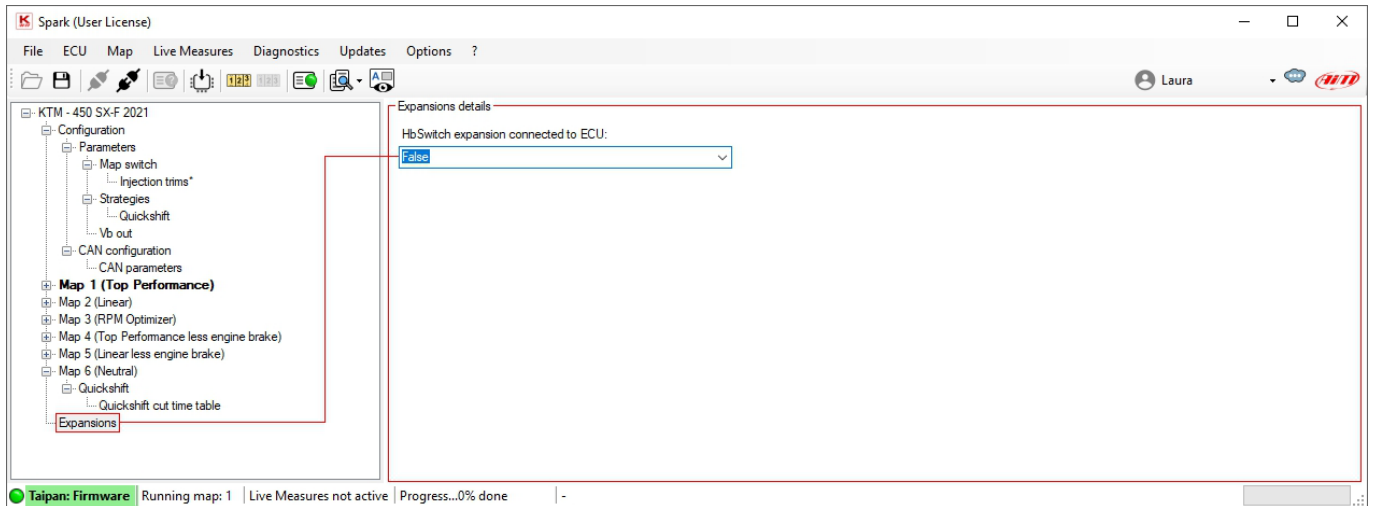

Once “Expansions” set to “False” you can decide whether having a CAN output or not (AUX CAN enabled/disabled) as shown here below.

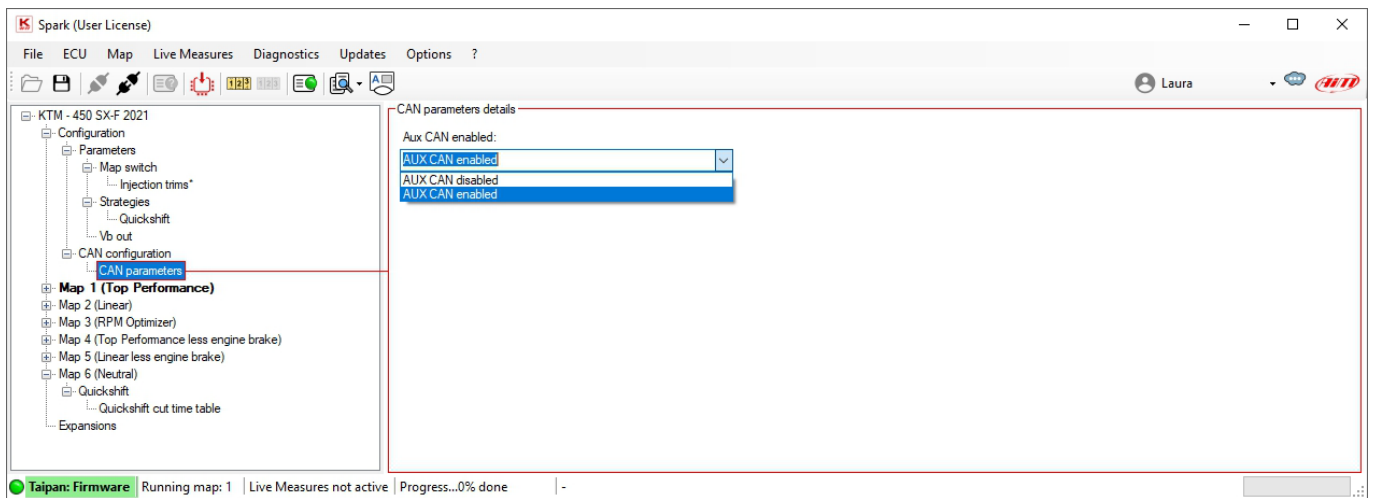

6.4.5 – Maps

Left of the software view are shown the available maps included in the configuration.

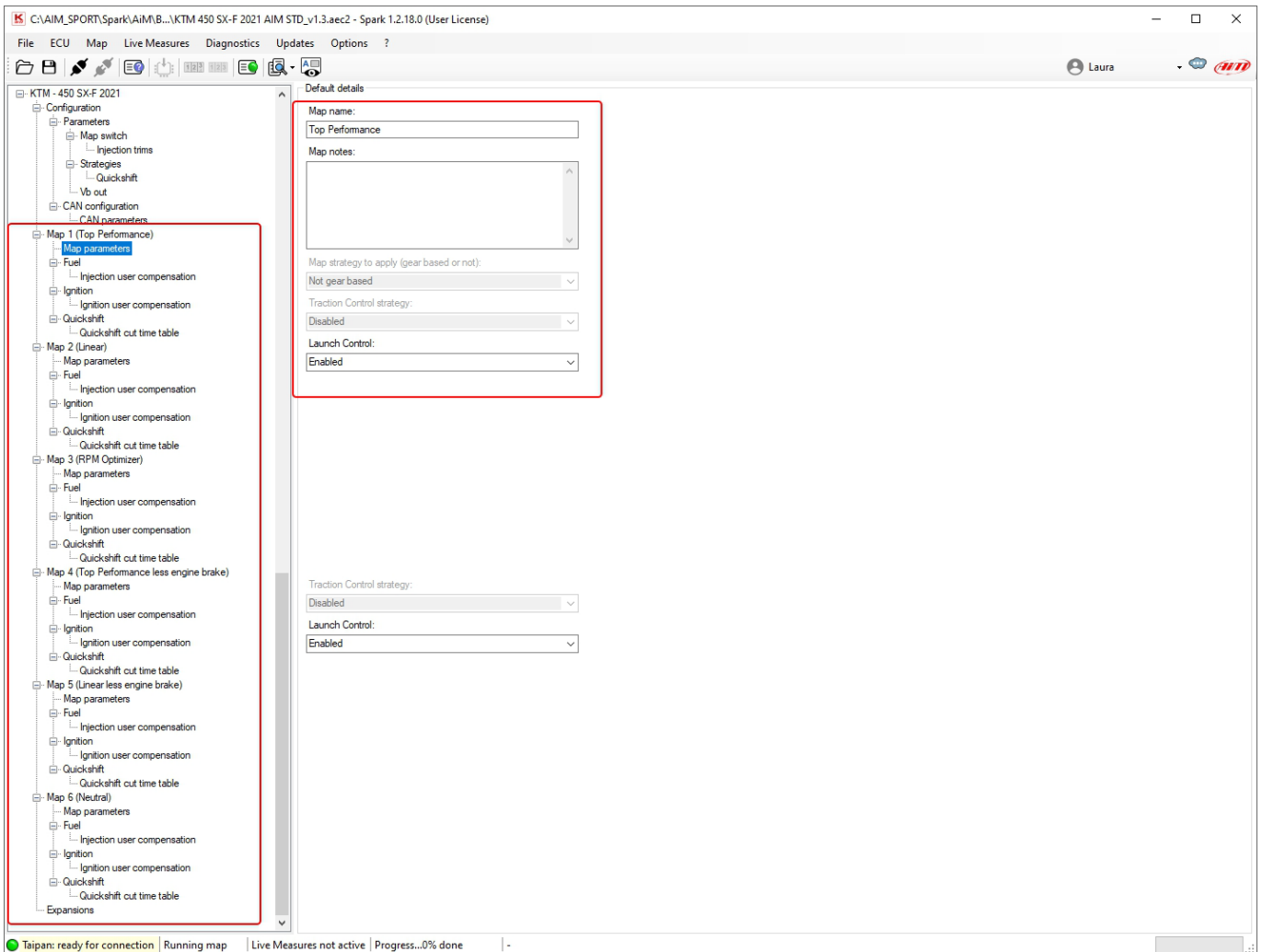

Here is possible to select a map from the tree view. Right of the software view are some details of the selected map you can look at but not modify:

- **Map name:** Top performance in the example
- **Map notes:** none in the example
- **Map strategy to apply (gear based or not):** the map strategy may be: gear based or not Gear based (as in the example)
- **Traction Control Strategy:** enabled or disabled as in the example. **Please note:** if Traction Control is enabled the ECU has dedicated parameters for each map.
- **Launch Control:** enabled (as in the example) or disabled; **Please note:** if Launch Control is enabled the ECU has a dedicated launch control main table for each map.

Coming back to the left part of the view and opening “Quickshift” option in the tree view you see “Quickshift cut time table”. Selecting it you can modify the entry points of the Quickshift strategy as shown in the table below.

Please note: the entry points of that table indicate the cut time of the ignition or the injection or both according to the applied Quickshift strategy.

Map 1 - Quickshift.Quickshift cut time table (ms)

| Tps (%) | rpm | 500 | 1000 | 1500 | 2000 | 2500 | 3000 | 3500 | 4000 | 4500 | 5000 | 5500 | 6000 | 6500 | 7000 | 7500 | 8000 | 8500 | 9000 | 9500 | 10000 | 10500 | 11000 | 11500 | 12000 | 12500 | 13000 | 13 | |
|---------|-----|-----|------|------|------|------|------|------|------|------|------|------|------|------|------|------|------|------|------|------|-------|-------|-------|-------|-------|-------|-------|----|----|
| 0.0 | 50 | 50 | 50 | 50 | 50 | 50 | 50 | 50 | 50 | 50 | 50 | 50 | 50 | 50 | 50 | 50 | 50 | 50 | 50 | 50 | 50 | 50 | 50 | 50 | 50 | 50 | 50 | 50 | |
| 2.5 | 50 | 50 | 50 | 50 | 50 | 50 | 50 | 50 | 50 | 50 | 50 | 50 | 50 | 50 | 50 | 50 | 50 | 50 | 50 | 50 | 50 | 50 | 50 | 50 | 50 | 50 | 50 | 50 | 50 |
| 5.0 | 50 | 50 | 50 | 50 | 50 | 50 | 50 | 50 | 50 | 50 | 50 | 50 | 50 | 50 | 50 | 50 | 50 | 50 | 50 | 50 | 50 | 50 | 50 | 50 | 50 | 50 | 50 | 50 | 50 |
| 10.0 | 50 | 50 | 50 | 50 | 50 | 50 | 50 | 50 | 50 | 50 | 50 | 50 | 50 | 50 | 50 | 50 | 50 | 50 | 50 | 50 | 50 | 50 | 50 | 50 | 50 | 50 | 50 | 50 | 50 |
| 25.0 | 50 | 50 | 50 | 50 | 50 | 50 | 50 | 50 | 50 | 50 | 50 | 50 | 50 | 50 | 50 | 50 | 50 | 50 | 50 | 50 | 50 | 50 | 50 | 50 | 50 | 50 | 50 | 50 | 50 |
| 33.0 | 50 | 50 | 50 | 50 | 50 | 50 | 50 | 50 | 50 | 50 | 50 | 50 | 50 | 50 | 50 | 50 | 50 | 50 | 50 | 50 | 50 | 50 | 50 | 50 | 50 | 50 | 50 | 50 | 50 |
| 50.0 | 50 | 50 | 50 | 50 | 50 | 50 | 50 | 50 | 50 | 50 | 50 | 50 | 50 | 50 | 50 | 50 | 50 | 50 | 50 | 50 | 50 | 50 | 50 | 50 | 50 | 50 | 50 | 50 | 50 |
| 66.0 | 45 | 45 | 45 | 45 | 45 | 45 | 45 | 45 | 45 | 45 | 45 | 45 | 45 | 45 | 45 | 45 | 45 | 45 | 45 | 45 | 45 | 45 | 45 | 45 | 45 | 45 | 45 | 45 | 45 |
| 75.0 | 45 | 45 | 45 | 45 | 45 | 45 | 45 | 45 | 45 | 45 | 45 | 45 | 45 | 45 | 45 | 45 | 45 | 45 | 45 | 45 | 45 | 45 | 45 | 45 | 45 | 45 | 45 | 45 | 45 |
| 100.0 | 45 | 45 | 45 | 45 | 45 | 45 | 45 | 45 | 45 | 45 | 45 | 45 | 45 | 45 | 45 | 45 | 45 | 45 | 45 | 45 | 45 | 45 | 45 | 45 | 45 | 45 | 45 | 45 | 45 |

X: rpm (min: 0, max: 20000)
Y: Tps (%) (min: 0.0, max: 100.0)
f(X, Y): ms (min: 0, max: 1000)

Quickshift panel (right of the software view) is made up of two layers:

- Table
- 2D
- 3D

Please refer to Data panel paragraph (6.5) for further information.

From Spark 1.1.8 onwards there is also the possibility with both user and tuner license to correct the injection/ignition base maps. More into details, below each map there are two user compensation tables as shown in the figure below:

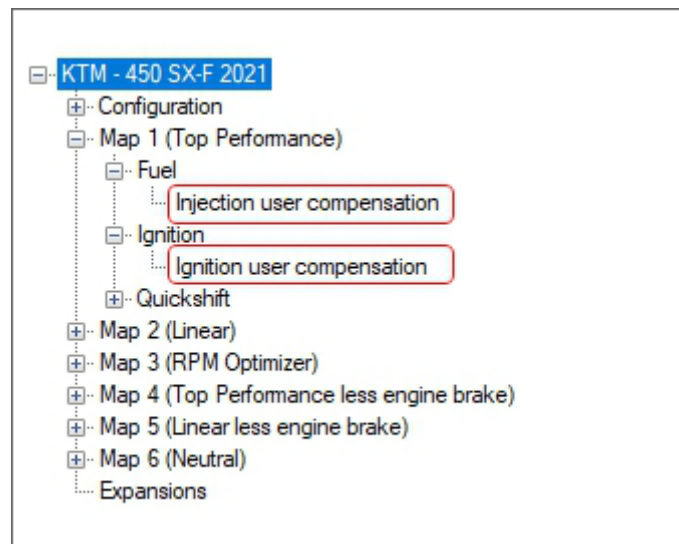



Injection user compensation table:

The fuel injection user compensation is a correction table where you can correct the injection time in percentage for each map, an example of an empty table is shown below. The correction range available is between +20% and -10%.

This means that if you are adding a + 10% in a point of this table the main injection map is corrected in that exact point by a 10% more of injection time.

Table 2D

Map 1 - Fuel Injection user compensation (%)

| Tps (%)\rpm | 1000 | 2000 | 3000 | 4000 | 5000 | 6000 | 7000 | 8000 | 9000 | 10000 | 11000 | 12000 | 13000 | 14000 | 15000 | 16000 |
|-------------|------|------|------|------|------|------|------|------|------|-------|-------|-------|-------|-------|-------|-------|
| 10.0 | 0.0 | 0.0 | 0.0 | 0.0 | 0.0 | 0.0 | 0.0 | 0.0 | 0.0 | 0.0 | 0.0 | 0.0 | 0.0 | 0.0 | 0.0 | 0.0 |
| 20.0 | 0.0 | 0.0 | 0.0 | 0.0 | 0.0 | 0.0 | 0.0 | 0.0 | 0.0 | 0.0 | 0.0 | 0.0 | 0.0 | 0.0 | 0.0 | 0.0 |
| 30.0 | 0.0 | 0.0 | 0.0 | 0.0 | 0.0 | 0.0 | 0.0 | 0.0 | 0.0 | 0.0 | 0.0 | 0.0 | 0.0 | 0.0 | 0.0 | 0.0 |
| 40.0 | 0.0 | 0.0 | 0.0 | 0.0 | 0.0 | 0.0 | 0.0 | 0.0 | 0.0 | 0.0 | 0.0 | 0.0 | 0.0 | 0.0 | 0.0 | 0.0 |
| 50.0 | 0.0 | 0.0 | 0.0 | 0.0 | 0.0 | 0.0 | 0.0 | 0.0 | 0.0 | 0.0 | 0.0 | 0.0 | 0.0 | 0.0 | 0.0 | 0.0 |
| 60.0 | 0.0 | 0.0 | 0.0 | 0.0 | 0.0 | 0.0 | 0.0 | 0.0 | 0.0 | 0.0 | 0.0 | 0.0 | 0.0 | 0.0 | 0.0 | 0.0 |
| 70.0 | 0.0 | 0.0 | 0.0 | 0.0 | 0.0 | 0.0 | 0.0 | 0.0 | 0.0 | 0.0 | 0.0 | 0.0 | 0.0 | 0.0 | 0.0 | 0.0 |
| 80.0 | 0.0 | 0.0 | 0.0 | 0.0 | 0.0 | 0.0 | 0.0 | 0.0 | 0.0 | 0.0 | 0.0 | 0.0 | 0.0 | 0.0 | 0.0 | 0.0 |
| 90.0 | 0.0 | 0.0 | 0.0 | 0.0 | 0.0 | 0.0 | 0.0 | 0.0 | 0.0 | 0.0 | 0.0 | 0.0 | 0.0 | 0.0 | 0.0 | 0.0 |
| 100.0 | 0.0 | 0.0 | 0.0 | 0.0 | 0.0 | 0.0 | 0.0 | 0.0 | 0.0 | 0.0 | 0.0 | 0.0 | 0.0 | 0.0 | 0.0 | 0.0 |

X: rpm (min: 0, max: 20000)
Y: Tps (%) (min: 0.0, max: 100.0)
f(X, Y): % (min: -10.0, max: 20.0)

Lock breakpoints



Ignition user compensation table:

The ignition user compensation table is a correction table where you can correct the advance in degrees for each map. The thresholds to be respected are between 3.0 ° and – 5.0° in term of advance. In other words, if you are adding in a point a –2° of advance the main ignition map is corrected by a –2° of advance in that exact point resulting in a delay in terms of ignition advance degrees. An example of an empty ignition user compensation table is shown below:

Table 2D

Map 1 - Ignition.Ignition user compensation (Advance (°))

| Tps (%)\rpm | 1000 | 2000 | 3000 | 4000 | 5000 | 6000 | 7000 | 8000 | 9000 | 10000 | 11000 | 12000 | 13000 | 14000 | 15000 | 16000 |
|-------------|------|------|------|------|------|------|------|------|------|-------|-------|-------|-------|-------|-------|-------|
| 10.0 | 0.0 | 0.0 | 0.0 | 0.0 | 0.0 | 0.0 | 0.0 | 0.0 | 0.0 | 0.0 | 0.0 | 0.0 | 0.0 | 0.0 | 0.0 | 0.0 |
| 20.0 | 0.0 | 0.0 | 0.0 | 0.0 | 0.0 | 0.0 | 0.0 | 0.0 | 0.0 | 0.0 | 0.0 | 0.0 | 0.0 | 0.0 | 0.0 | 0.0 |
| 30.0 | 0.0 | 0.0 | 0.0 | 0.0 | 0.0 | 0.0 | 0.0 | 0.0 | 0.0 | 0.0 | 0.0 | 0.0 | 0.0 | 0.0 | 0.0 | 0.0 |
| 40.0 | 0.0 | 0.0 | 0.0 | 0.0 | 0.0 | 0.0 | 0.0 | 0.0 | 0.0 | 0.0 | 0.0 | 0.0 | 0.0 | 0.0 | 0.0 | 0.0 |
| 50.0 | 0.0 | 0.0 | 0.0 | 0.0 | 0.0 | 0.0 | 0.0 | 0.0 | 0.0 | 0.0 | 0.0 | 0.0 | 0.0 | 0.0 | 0.0 | 0.0 |
| 60.0 | 0.0 | 0.0 | 0.0 | 0.0 | 0.0 | 0.0 | 0.0 | 0.0 | 0.0 | 0.0 | 0.0 | 0.0 | 0.0 | 0.0 | 0.0 | 0.0 |
| 70.0 | 0.0 | 0.0 | 0.0 | 0.0 | 0.0 | 0.0 | 0.0 | 0.0 | 0.0 | 0.0 | 0.0 | 0.0 | 0.0 | 0.0 | 0.0 | 0.0 |
| 80.0 | 0.0 | 0.0 | 0.0 | 0.0 | 0.0 | 0.0 | 0.0 | 0.0 | 0.0 | 0.0 | 0.0 | 0.0 | 0.0 | 0.0 | 0.0 | 0.0 |
| 90.0 | 0.0 | 0.0 | 0.0 | 0.0 | 0.0 | 0.0 | 0.0 | 0.0 | 0.0 | 0.0 | 0.0 | 0.0 | 0.0 | 0.0 | 0.0 | 0.0 |
| 100.0 | 0.0 | 0.0 | 0.0 | 0.0 | 0.0 | 0.0 | 0.0 | 0.0 | 0.0 | 0.0 | 0.0 | 0.0 | 0.0 | 0.0 | 0.0 | 0.0 |

X: rpm (min: 0, max: 20000)
Y: Tps (%) (min: 0.0, max: 100.0)
f(X, Y): Advance (°) (min: -5.0, max: 3.0)

Lock breakpoints

Please remember that, to apply the changes made to the user compensation tables you need to connect the UC-bridge to the PC and to the ECU and write the previously modified map using the command "Write ECU" or the shortcut ALT+MAIUSC+E.

6.4.6 – Expansions

Here you can enable/disable the Handlebar switch. Set it to True if connected and to False if not connected.

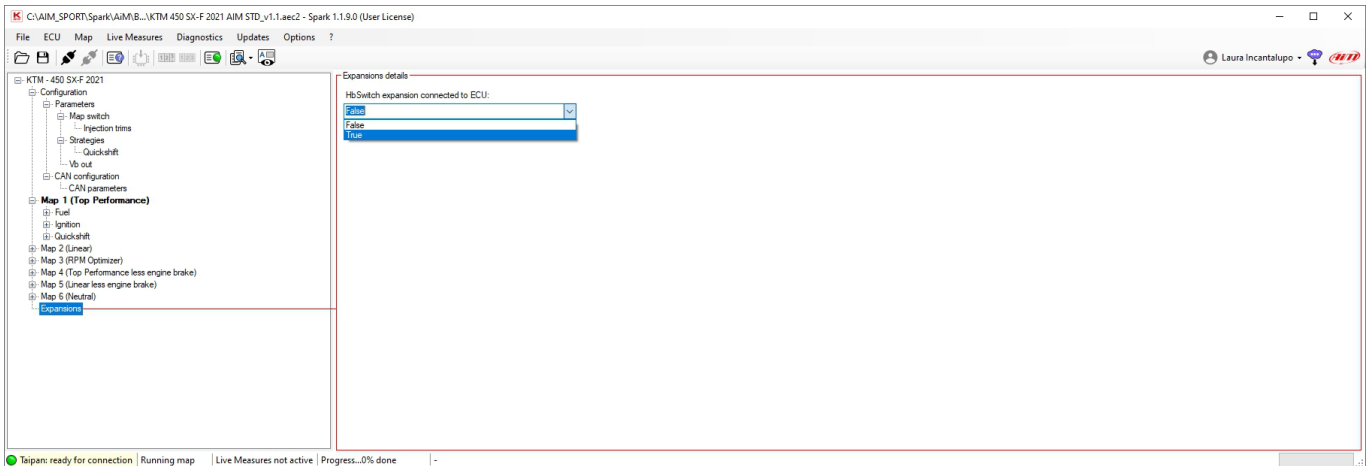

6.5 – Data Panel

As said before Data panel right of the software view is made up of three layers that shows the mapping tables in three different ways:

- Table format
- 2D
- 3D

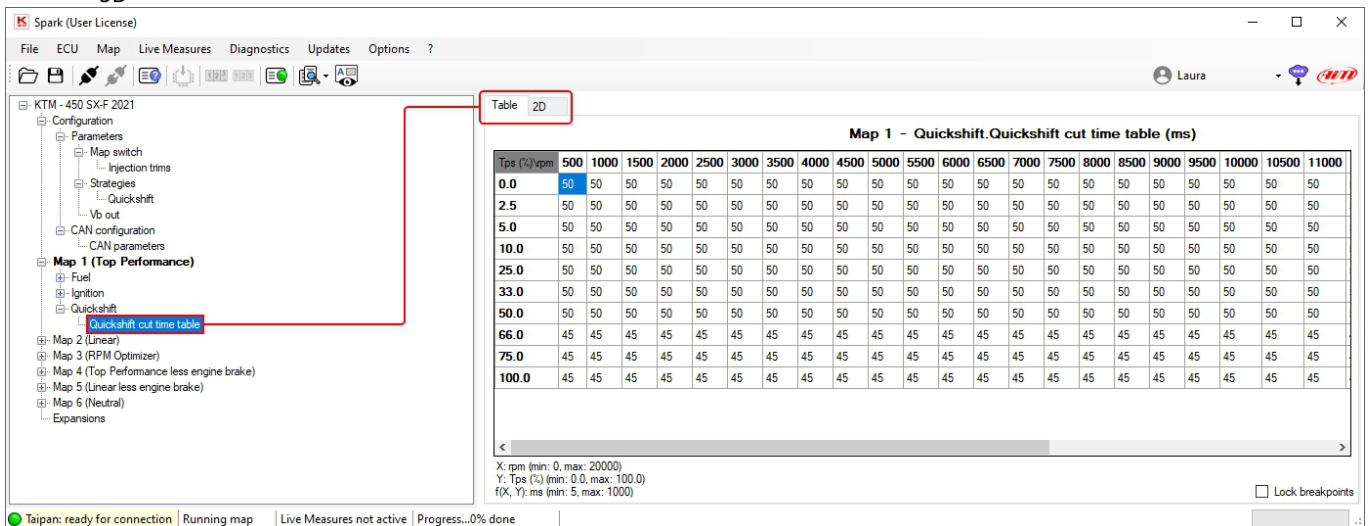

Click any layer or use the shortcut “Enter key+Ctrl + 1 or 2 or 3” to enable the views. Please note digits stay for:

- 1: Table view
- 2: 2D view

6.5.1 – Table format

All tables can be pinned/unpinned in the software view using these icons you find top right of the software panels that allows this function. The panels hook/unhook from spark main window allowing the user to displace and resize it as desired, saving all functions. Once the window unhooked the icon switches to “Pin” icon indicating that if pressed the panel re-hooks to the main one.

Selecting a single cell in the table and pressing “CTRL+L” all cells of the row will be selected.

In this view you can change both entries and breakpoints of the cells. Entries can be modified one by one or grouped selecting them with the mouse or with shift + arrow keys. To **select** a group of entries:

- using the mouse left click on the desired table zone
- by keyboard use Shift + Arrows keys moving up to select the desired zone

Please note: the software only accepts numbers in multiples of 5.

To **change** cells **values** using the **mouse**:

- Double click on the cell you want to modify and it becomes editable: fill in the desired value
- Right click on the cell you want to modify, “Edit table” tooltip is prompted, select it. Available options are:
 - entering a value in the top left cell the software allows the user to perform addition, addition percentage or setting the single value across all selected items in the table
 - entering a value in either the horizontal or the vertical cell respectively enables the user to choose if performing addition, addition percentage or setting linearized values of the selected items horizontally or vertically
 - entering values in all three cells allows the user to perform a bi-directional addition, addition percentage or setting operations

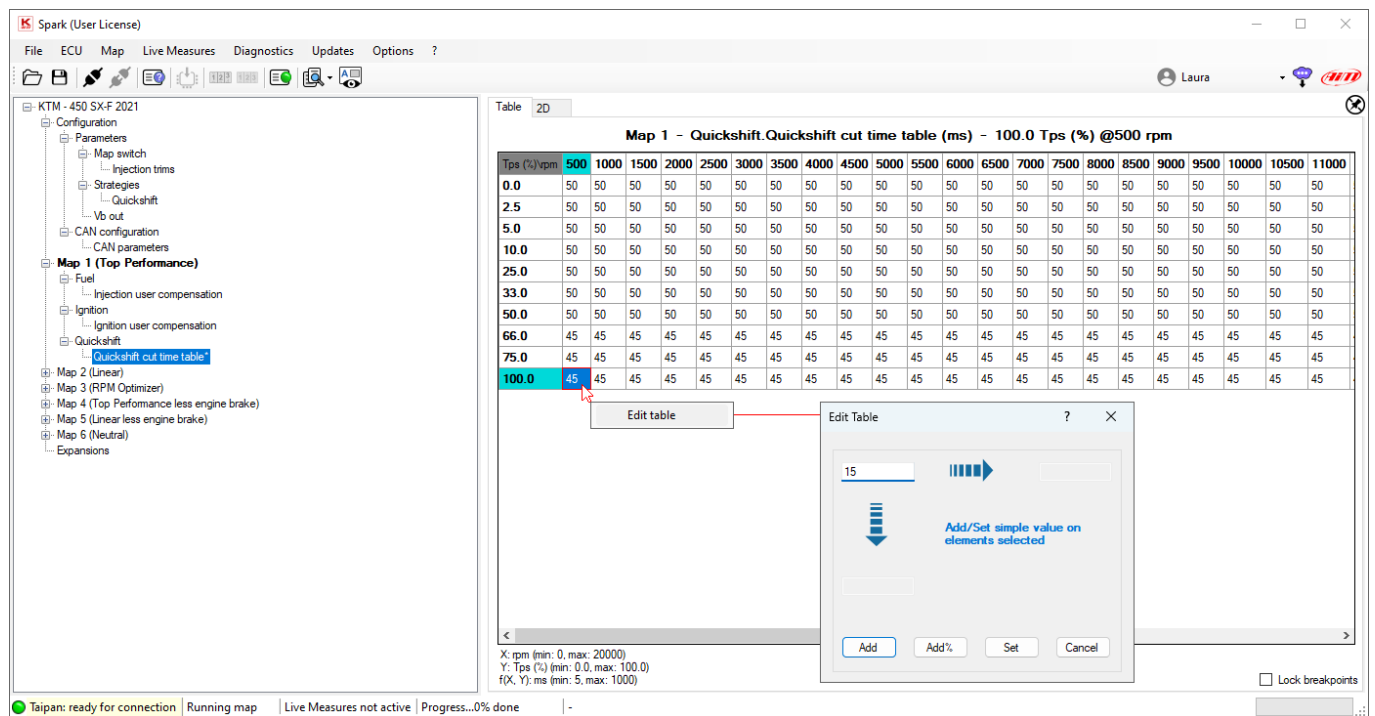

To **change** cells **values** using the keyboard select the cell and use these keys:

- Ctrl+Up -> Increment the selected entries for entry resolution x 10.
- Ctrl+Down -> Decrement the selected entries for entry resolution x 10.
- Type in the value -> Force all entries to the desired number (as said all numbers have to be multiples of 5).
- **Breakpoints can be locked** to avoid unintentional changes. This is done enabling the checkbox right bottom of Data view area.



Once data have been changed, modified cells are highlighted in **orange** to show that the data is changed but **not yet sent to Taipan**.

Table 2D

Map 1 - Quickshift.Quickshift cut time table (ms) - 0.0Tps (%) @500rpm

| Tps (%)\rpm | 500 | 1000 | 1500 | 2000 | 2500 | 3000 | 3500 | 4000 | 4500 | 5000 | 5500 | 6000 | 6500 | 7000 | 7500 | 8000 | 8500 | 9000 | 9500 | 10000 | 10500 | 11000 | 1 | | |
|-------------|-----|------|------|------|------|------|------|------|------|------|------|------|------|------|------|------|------|------|------|-------|-------|-------|----|----|---|
| 0.0 | 50 | 50 | 50 | 50 | 50 | 50 | 50 | 50 | 50 | 50 | 50 | 50 | 50 | 50 | 50 | 50 | 50 | 50 | 50 | 50 | 50 | 50 | 50 | 5 | |
| 2.5 | 50 | 50 | 50 | 50 | 50 | 50 | 50 | 50 | 50 | 50 | 50 | 50 | 50 | 50 | 50 | 50 | 50 | 50 | 50 | 50 | 50 | 50 | 50 | 50 | 5 |
| 5.0 | 50 | 50 | 50 | 50 | 50 | 50 | 50 | 50 | 50 | 50 | 50 | 50 | 50 | 50 | 50 | 50 | 50 | 50 | 50 | 50 | 50 | 50 | 50 | 50 | 5 |
| 10.0 | 50 | 50 | 50 | 50 | 50 | 50 | 50 | 50 | 50 | 50 | 50 | 50 | 50 | 50 | 50 | 50 | 50 | 50 | 50 | 50 | 50 | 50 | 50 | 50 | 5 |
| 25.0 | 50 | 50 | 50 | 50 | 50 | 50 | 50 | 50 | 50 | 50 | 50 | 50 | 50 | 50 | 50 | 50 | 50 | 50 | 50 | 50 | 50 | 50 | 50 | 50 | 5 |
| 33.0 | 50 | 50 | 50 | 50 | 50 | 50 | 50 | 50 | 50 | 50 | 50 | 50 | 50 | 50 | 50 | 50 | 50 | 50 | 50 | 50 | 50 | 50 | 50 | 50 | 5 |
| 50.0 | 50 | 50 | 50 | 50 | 50 | 50 | 50 | 50 | 50 | 50 | 50 | 50 | 50 | 50 | 50 | 50 | 50 | 50 | 50 | 50 | 50 | 50 | 50 | 50 | 5 |
| 66.0 | 45 | 45 | 45 | 45 | 45 | 45 | 45 | 45 | 45 | 45 | 45 | 45 | 45 | 45 | 45 | 45 | 45 | 45 | 45 | 45 | 45 | 45 | 45 | 45 | 4 |
| 75.0 | 45 | 45 | 45 | 45 | 45 | 45 | 45 | 45 | 45 | 45 | 45 | 45 | 45 | 45 | 45 | 45 | 45 | 45 | 45 | 45 | 45 | 45 | 45 | 45 | 4 |
| 100.0 | 105 | 45 | 45 | 45 | 45 | 45 | 45 | 45 | 45 | 45 | 45 | 45 | 45 | 45 | 45 | 45 | 45 | 45 | 45 | 45 | 45 | 45 | 45 | 45 | 4 |

X: rpm (min: 0, max: 20000)
 Y: Tps (%) (min: 0.0, max: 100.0)
 f(X, Y): ms (min: 5, max: 1000)

Lock breakpoints

To send it to the ECU push enter on the keyboard, and the changes will be transmitted to the ECU and highlighted in **green** to show that they have been **written in temporary way**. This means that they have not been flashed into the ECU for permanent use so if you unplug Taipan and then plug it again changes will be lost.

Table 2D

Map 1 - Quickshift.Quickshift cut time table (ms) - 0.0Tps (%) @500rpm

| Tps (%)\rpm | 500 | 1000 | 1500 | 2000 | 2500 | 3000 | 3500 | 4000 | 4500 | 5000 | 5500 | 6000 | 6500 | 7000 | 7500 | 8000 | 8500 | 9000 | 9500 | 10000 | 10500 | 11000 | 1 | | |
|-------------|-----|------|------|------|------|------|------|------|------|------|------|------|------|------|------|------|------|------|------|-------|-------|-------|----|----|---|
| 0.0 | 50 | 50 | 50 | 50 | 50 | 50 | 50 | 50 | 50 | 50 | 50 | 50 | 50 | 50 | 50 | 50 | 50 | 50 | 50 | 50 | 50 | 50 | 50 | 5 | |
| 2.5 | 50 | 50 | 50 | 50 | 50 | 50 | 50 | 50 | 50 | 50 | 50 | 50 | 50 | 50 | 50 | 50 | 50 | 50 | 50 | 50 | 50 | 50 | 50 | 50 | 5 |
| 5.0 | 50 | 50 | 50 | 50 | 50 | 50 | 50 | 50 | 50 | 50 | 50 | 50 | 50 | 50 | 50 | 50 | 50 | 50 | 50 | 50 | 50 | 50 | 50 | 50 | 5 |
| 10.0 | 50 | 50 | 50 | 50 | 50 | 50 | 50 | 50 | 50 | 50 | 50 | 50 | 50 | 50 | 50 | 50 | 50 | 50 | 50 | 50 | 50 | 50 | 50 | 50 | 5 |
| 25.0 | 50 | 50 | 50 | 50 | 50 | 50 | 50 | 50 | 50 | 50 | 50 | 50 | 50 | 50 | 50 | 50 | 50 | 50 | 50 | 50 | 50 | 50 | 50 | 50 | 5 |
| 33.0 | 50 | 50 | 50 | 50 | 50 | 50 | 50 | 50 | 50 | 50 | 50 | 50 | 50 | 50 | 50 | 50 | 50 | 50 | 50 | 50 | 50 | 50 | 50 | 50 | 5 |
| 50.0 | 50 | 50 | 50 | 50 | 50 | 50 | 50 | 50 | 50 | 50 | 50 | 50 | 50 | 50 | 50 | 50 | 50 | 50 | 50 | 50 | 50 | 50 | 50 | 50 | 5 |
| 66.0 | 45 | 45 | 45 | 45 | 45 | 45 | 45 | 45 | 45 | 45 | 45 | 45 | 45 | 45 | 45 | 45 | 45 | 45 | 45 | 45 | 45 | 45 | 45 | 45 | 4 |
| 75.0 | 45 | 45 | 45 | 45 | 45 | 45 | 45 | 45 | 45 | 45 | 45 | 45 | 45 | 45 | 45 | 45 | 45 | 45 | 45 | 45 | 45 | 45 | 45 | 45 | 4 |
| 100.0 | 105 | 45 | 45 | 45 | 45 | 45 | 45 | 45 | 45 | 45 | 45 | 45 | 45 | 45 | 45 | 45 | 45 | 45 | 45 | 45 | 45 | 45 | 45 | 45 | 4 |

X: rpm (min: 0, max: 20000)
 Y: Tps (%) (min: 0.0, max: 100.0)
 f(X, Y): ms (min: 5, max: 1000)

Lock breakpoints

To **write permanently all changes** directly into the ECU it is necessary to save the project (File -> Save ECU project as) and write it in the ECU (ECU -> Write ECU) as shown here below.

To write only the **“Quickshift cut time table”** just changed, it is possible to use the shortcut **“Alt+Shift+T”**

To read the whole table use the shortcut: **“Alt+T”**

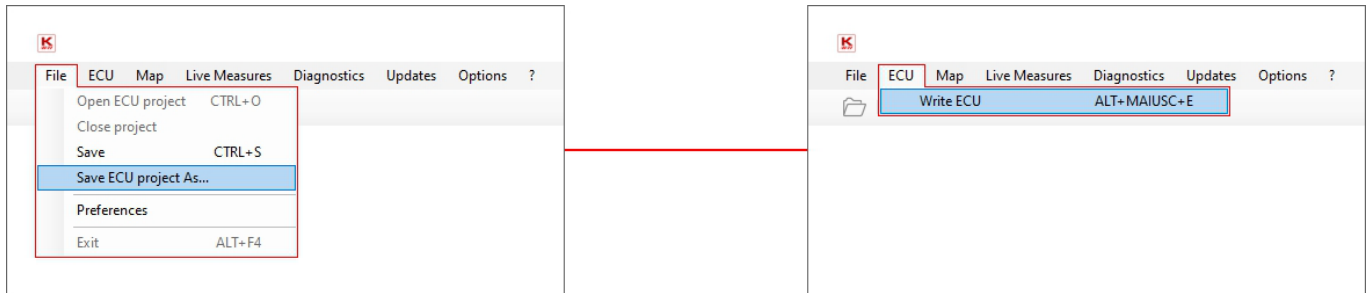



6.5.2 – Interpolation on: row, column and bilinear

Selecting one or more **rows** of values and right clicking on the selection “Linear interpolation row” menu is enabled and values are interpolated according to horizontal breakpoints and selected columns.

The screenshot shows a software window titled "C:\AIM_SPORT\Spark\User\KTM - 250 SX 2024_test.aec2 - Spark 1.2.78.0 (User License)". The main area displays a table titled "Map 1 - Fuel.Injection user compensation (%) - 25.0 Tps (%) @12000 rpm". The table has columns for RPM (1000 to 16000) and rows for TPS (0.0 to 100.0). A context menu is open over the table with the following options: "Edit table", "Smoothing", and "Linear Interpolation Row". The "Linear Interpolation Row" option is highlighted with a red box. Below the table, there are control panels for RPM, TPS, ECT, IAT, VIGN, and ENG STATE. The status bar at the bottom shows "Taipan K: ready for connection | Running map: 1 | Live Measures not active | Progress...0% done".

| Tps (%)/rpm | 1000 | 2000 | 3000 | 4000 | 5000 | 6000 | 7000 | 8000 | 9000 | 10000 | 11000 | 12000 | 13000 | 14000 | 15000 | 16000 |
|-------------|------|------|------|------|------|------|------|------|------|-------|-------|-------|-------|-------|-------|-------|
| 0.0 | 0.0 | 0.0 | 0.0 | 0.0 | 0.0 | 0.0 | 0.0 | 0.0 | 0.0 | 0.0 | 0.0 | 0.0 | 0.0 | 0.0 | 0.0 | 0.0 |
| 2.5 | 0.0 | 0.0 | 0.0 | 0.0 | 0.0 | 0.0 | 0.0 | 0.0 | 0.0 | 0.0 | 0.0 | 0.0 | 0.0 | 0.0 | 0.0 | 0.0 |
| 5.0 | 0.0 | 0.0 | 0.0 | 0.0 | 0.0 | 0.0 | 0.0 | 0.0 | 0.0 | 0.0 | 0.0 | 0.0 | 0.0 | 0.0 | 0.0 | 0.0 |
| 10.0 | 0.0 | 0.0 | 0.0 | 0.0 | 0.0 | 0.0 | 0.0 | 0.0 | 0.0 | 0.0 | 0.0 | 0.0 | 0.0 | 0.0 | 0.0 | 0.0 |
| 25.0 | 0.0 | 0.0 | 0.0 | 0.0 | 0.0 | 0.0 | 0.0 | 0.0 | 0.0 | 0.0 | 0.0 | 0.0 | 0.0 | 0.0 | 0.0 | 0.0 |
| 33.0 | 0.0 | 0.0 | 0.0 | 0.0 | 0.0 | 0.0 | 0.0 | 0.0 | 0.0 | 0.0 | 0.0 | 0.0 | 0.0 | 0.0 | 0.0 | 0.0 |
| 50.0 | 0.0 | 0.0 | 0.0 | 0.0 | 0.0 | 0.0 | 0.0 | 0.0 | 0.0 | 0.0 | 0.0 | 0.0 | 0.0 | 0.0 | 0.0 | 0.0 |
| 66.0 | 0.0 | 0.0 | 0.0 | 0.0 | 0.0 | 0.0 | 0.0 | 0.0 | 0.0 | 0.0 | 0.0 | 0.0 | 0.0 | 0.0 | 0.0 | 0.0 |
| 75.0 | 0.0 | 0.0 | 0.0 | 0.0 | 0.0 | 0.0 | 0.0 | 0.0 | 0.0 | 0.0 | 0.0 | 0.0 | 0.0 | 0.0 | 0.0 | 0.0 |
| 100.0 | 0.0 | 0.0 | 0.0 | 0.0 | 0.0 | 0.0 | 0.0 | 0.0 | 0.0 | 0.0 | 0.0 | 0.0 | 0.0 | 0.0 | 0.0 | 0.0 |

Selecting one or more **columns** of values and right clicking on the selection "Linear interpolation column" menu is enabled and values are interpolated according to horizontal breakpoints and selected columns.

The screenshot shows the software interface for editing a table. The table is titled "Map 1 - Fuel Injection user compensation (%) - 66.0 Tps (%) @3000 rpm". The table has 17 columns representing RPM values from 1000 to 16000 and 10 rows representing TPS values from 0.0 to 100.0. The cell at the intersection of 3000 RPM and 66.0 TPS is highlighted in blue. A context menu is open over this cell, with the option "Linear Interpolation Column" selected and highlighted in red.

| Tps (%)rpm | 1000 | 2000 | 3000 | 4000 | 5000 | 6000 | 7000 | 8000 | 9000 | 10000 | 11000 | 12000 | 13000 | 14000 | 15000 | 16000 |
|------------|------|------|------|------|------|------|------|------|------|-------|-------|-------|-------|-------|-------|-------|
| 0.0 | 0.0 | 0.0 | 0.0 | 0.0 | 0.0 | 0.0 | 0.0 | 0.0 | 0.0 | 0.0 | 0.0 | 0.0 | 0.0 | 0.0 | 0.0 | 0.0 |
| 2.5 | 0.0 | 0.0 | 0.0 | 0.0 | 0.0 | 0.0 | 0.0 | 0.0 | 0.0 | 0.0 | 0.0 | 0.0 | 0.0 | 0.0 | 0.0 | 0.0 |
| 5.0 | 0.0 | 0.0 | 0.0 | 0.0 | 0.0 | 0.0 | 0.0 | 0.0 | 0.0 | 0.0 | 0.0 | 0.0 | 0.0 | 0.0 | 0.0 | 0.0 |
| 10.0 | 0.0 | 0.0 | 0.0 | 0.0 | 0.0 | 0.0 | 0.0 | 0.0 | 0.0 | 0.0 | 0.0 | 0.0 | 0.0 | 0.0 | 0.0 | 0.0 |
| 25.0 | 0.0 | 0.0 | 0.0 | 0.0 | 0.0 | 0.0 | 0.0 | 0.0 | 0.0 | 0.0 | 0.0 | 0.0 | 0.0 | 0.0 | 0.0 | 0.0 |
| 33.0 | 0.0 | 0.0 | 0.0 | 0.0 | 0.0 | 0.0 | 0.0 | 0.0 | 0.0 | 0.0 | 0.0 | 0.0 | 0.0 | 0.0 | 0.0 | 0.0 |
| 50.0 | 0.0 | 0.0 | 0.0 | 0.0 | 0.0 | 0.0 | 0.0 | 0.0 | 0.0 | 0.0 | 0.0 | 0.0 | 0.0 | 0.0 | 0.0 | 0.0 |
| 66.0 | 0.0 | 0.0 | 0.0 | 0.0 | 0.0 | 0.0 | 0.0 | 0.0 | 0.0 | 0.0 | 0.0 | 0.0 | 0.0 | 0.0 | 0.0 | 0.0 |
| 75.0 | 0.0 | 0.0 | 0.0 | 0.0 | 0.0 | 0.0 | 0.0 | 0.0 | 0.0 | 0.0 | 0.0 | 0.0 | 0.0 | 0.0 | 0.0 | 0.0 |
| 100.0 | 0.0 | 0.0 | 0.0 | 0.0 | 0.0 | 0.0 | 0.0 | 0.0 | 0.0 | 0.0 | 0.0 | 0.0 | 0.0 | 0.0 | 0.0 | 0.0 |

Below the table, there are control elements for RPM, ECT, VIGN, and ENG STATE, and a graph area showing a plot of the data.



Selecting a range that includes **rows and columns** of values you can decide the desired interpolation to be made: for rows, for columns or **bilinear**. Choosing bilinear option the software performs first an interpolation for rows, that for columns always taking into accounts the values of horizontal and vertical breakpoints.

The screenshot shows the software interface for editing a table. The table is titled "Map 1 - Fuel Injection user compensation (%) - 50.0 Tps (%) @8000 rpm". The table has 17 columns for Tps (%) from 0.0 to 16000 and 11 rows for rpm from 0.0 to 100.0. A context menu is open over the table, with the "Bilinear Interpolation" option highlighted. The menu also includes "Edit table", "Smoothing", "Linear Interpolation Row", and "Linear Interpolation Column".

| Tps (%)rpm | 1000 | 2000 | 3000 | 4000 | 5000 | 6000 | 7000 | 8000 | 9000 | 10000 | 11000 | 12000 | 13000 | 14000 | 15000 | 16000 |
|------------|------|------|------|------|------|------|------|------|------|-------|-------|-------|-------|-------|-------|-------|
| 0.0 | 0.0 | 0.0 | 0.0 | 0.0 | 0.0 | 0.0 | 0.0 | 0.0 | 0.0 | 0.0 | 0.0 | 0.0 | 0.0 | 0.0 | 0.0 | 0.0 |
| 2.5 | 0.0 | 0.0 | 0.0 | 0.0 | 0.0 | 0.0 | 0.0 | 0.0 | 0.0 | 0.0 | 0.0 | 0.0 | 0.0 | 0.0 | 0.0 | 0.0 |
| 5.0 | 0.0 | 0.0 | 0.0 | 0.0 | 0.0 | 0.0 | 0.0 | 0.0 | 0.0 | 0.0 | 0.0 | 0.0 | 0.0 | 0.0 | 0.0 | 0.0 |
| 10.0 | 0.0 | 0.0 | 0.0 | 0.0 | 0.0 | 0.0 | 0.0 | 0.0 | 0.0 | 0.0 | 0.0 | 0.0 | 0.0 | 0.0 | 0.0 | 0.0 |
| 25.0 | 0.0 | 0.0 | 0.0 | 0.0 | 0.0 | 0.0 | 0.0 | 0.0 | 0.0 | 0.0 | 0.0 | 0.0 | 0.0 | 0.0 | 0.0 | 0.0 |
| 33.0 | 0.0 | 0.0 | 0.0 | 0.0 | 0.0 | 0.0 | 0.0 | 0.0 | 0.0 | 0.0 | 0.0 | 0.0 | 0.0 | 0.0 | 0.0 | 0.0 |
| 50.0 | 0.0 | 0.0 | 0.0 | 0.0 | 0.0 | 0.0 | 0.0 | 0.0 | 0.0 | 0.0 | 0.0 | 0.0 | 0.0 | 0.0 | 0.0 | 0.0 |
| 66.0 | 0.0 | 0.0 | 0.0 | 0.0 | 0.0 | 0.0 | 0.0 | 0.0 | 0.0 | 0.0 | 0.0 | 0.0 | 0.0 | 0.0 | 0.0 | 0.0 |
| 75.0 | 0.0 | 0.0 | 0.0 | 0.0 | 0.0 | 0.0 | 0.0 | 0.0 | 0.0 | 0.0 | 0.0 | 0.0 | 0.0 | 0.0 | 0.0 | 0.0 |
| 100.0 | 0.0 | 0.0 | 0.0 | 0.0 | 0.0 | 0.0 | 0.0 | 0.0 | 0.0 | 0.0 | 0.0 | 0.0 | 0.0 | 0.0 | 0.0 | 0.0 |

6.5.3 – Smoothing

Selecting at least three contiguous cells and right clicking on them “Smoothing” menu is enabled: selecting the smoothing algorithm is applied. The images below show:

- graph with starting data top
- selection of smooting functionality central
- graphic effect on the data bottom

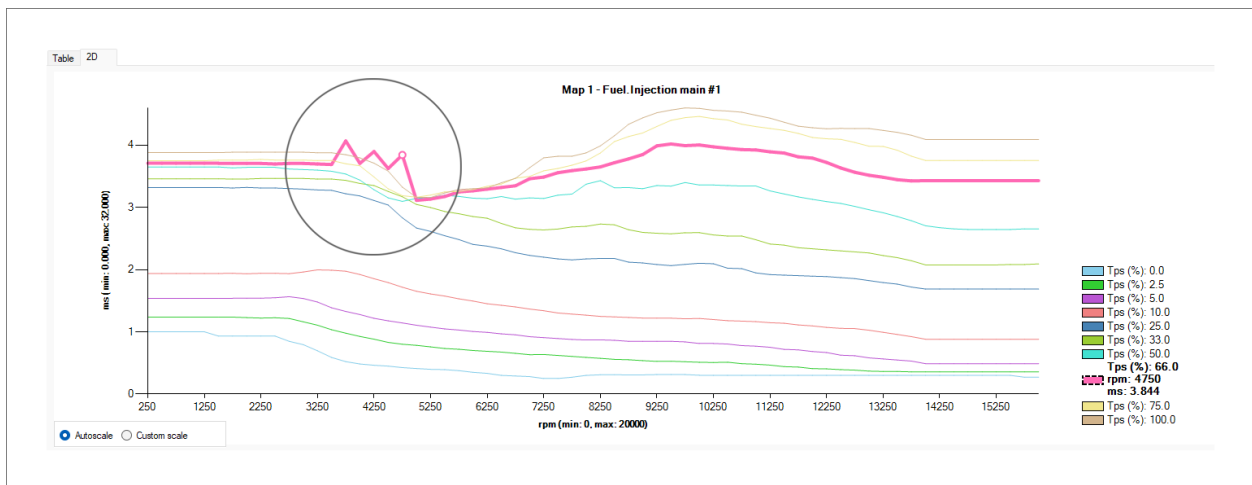

Table 2D

Map 3 - Fuel Injection main #1 (ms) - 100.0 Tps (%) @7500 rpm

| Tps (%)rpm | 3000 | 3250 | 3500 | 3750 | 4000 | 4250 | 4500 | 4750 | 5000 | 5250 | 5500 | 5750 | 6000 | 6250 | 6500 | 6750 | 7000 | 7250 | 7500 | 7750 | 8000 | 8250 | 8500 | 8750 | 9000 | 9250 | 9500 | 9750 | 10 | |
|------------|-------|-------|-------|-------|-------|-------|-------|-------|-------|-------|-------|-------|-------|-------|-------|-------|-------|-------|-------|-------|-------|-------|-------|-------|-------|-------|-------|-------|-----|--|
| 0.0 | 1.187 | 1.001 | 0.846 | 0.736 | 0.657 | 0.615 | 0.593 | 0.600 | 0.600 | 0.600 | 0.600 | 0.601 | 0.600 | 0.600 | 0.600 | 0.600 | 0.600 | 0.600 | 0.590 | 0.571 | 0.551 | 0.528 | 0.510 | 0.479 | 0.457 | 0.431 | 0.401 | 0.381 | 0.3 | |
| 2.5 | 2.002 | 1.860 | 1.707 | 1.510 | 1.378 | 1.253 | 1.160 | 1.060 | 0.990 | 0.930 | 0.910 | 0.900 | 0.870 | 0.850 | 0.820 | 0.810 | 0.780 | 0.780 | 0.726 | 0.686 | 0.667 | 0.647 | 0.639 | 0.620 | 0.602 | 0.602 | 0.583 | 0.564 | 0.5 | |
| 5.0 | 2.857 | 2.640 | 2.461 | 2.287 | 2.129 | 2.027 | 1.916 | 1.833 | 1.745 | 1.663 | 1.572 | 1.537 | 1.502 | 1.444 | 1.398 | 1.352 | 1.306 | 1.243 | 1.176 | 1.118 | 1.095 | 1.062 | 1.051 | 1.017 | 1.007 | 0.976 | 0.967 | 0.956 | 0.9 | |
| 10.0 | 3.661 | 3.365 | 2.951 | 2.732 | 2.625 | 2.491 | 2.403 | 2.397 | 2.383 | 2.451 | 2.503 | 2.503 | 2.447 | 2.336 | 2.243 | 2.168 | 2.100 | 2.046 | 2.005 | 1.931 | 1.867 | 1.792 | 1.771 | 1.716 | 1.686 | 1.607 | 1.505 | 1.451 | 1.3 | |
| 25.0 | 6.366 | 6.073 | 5.498 | 5.000 | 4.592 | 4.298 | 3.904 | 3.813 | 3.774 | 3.772 | 3.777 | 3.778 | 4.225 | 4.193 | 3.704 | 3.644 | 3.596 | 3.153 | 3.048 | 3.297 | 3.235 | 3.154 | 3.102 | 3.018 | 2.936 | 2.848 | 2.777 | 2.685 | 2.6 | |
| 38.0 | 7.997 | 7.516 | 7.217 | 6.345 | 5.944 | 5.764 | 5.659 | 5.593 | 5.604 | 5.628 | 5.671 | 5.688 | 6.112 | 6.030 | 5.483 | 5.396 | 5.299 | 4.824 | 4.731 | 4.914 | 4.784 | 4.633 | 4.503 | 4.330 | 4.164 | 4.009 | 3.831 | 3.738 | 3.6 | |
| 50.0 | 8.549 | 8.035 | 7.772 | 6.847 | 6.328 | 6.204 | 6.255 | 6.420 | 6.586 | 6.612 | 6.581 | 6.496 | 6.898 | 6.815 | 6.309 | 6.276 | 6.117 | 5.691 | 5.552 | 5.681 | 5.496 | 5.348 | 5.184 | 5.054 | 4.961 | 4.758 | 4.641 | 4.555 | 4.4 | |
| 60.0 | 8.848 | 8.417 | 7.726 | 6.434 | 6.072 | 6.175 | 6.471 | 6.639 | 6.834 | 7.019 | 7.266 | 7.415 | 8.052 | 8.254 | 7.921 | 7.926 | 7.894 | | | | | | | | | | | | | |
| 75.0 | 8.786 | 8.357 | 7.791 | 6.373 | 6.152 | 6.298 | 6.362 | 6.703 | 7.028 | 7.175 | 7.477 | 7.716 | 8.269 | 8.442 | 8.214 | 8.202 | 8.133 | | | | | | | | | | | | | |
| 100.0 | 8.876 | 8.403 | 8.051 | 7.594 | 7.413 | 7.390 | 7.247 | 7.331 | 7.660 | 7.849 | 8.249 | 8.477 | 8.739 | 9.170 | 9.438 | 9.523 | 9.452 | | | | | | | | | | | | | |

Context menu options:

- Edit table
- Smoothing
- Linear Interpolation Row
- Linear Interpolation Column
- Bilinear Interpolation

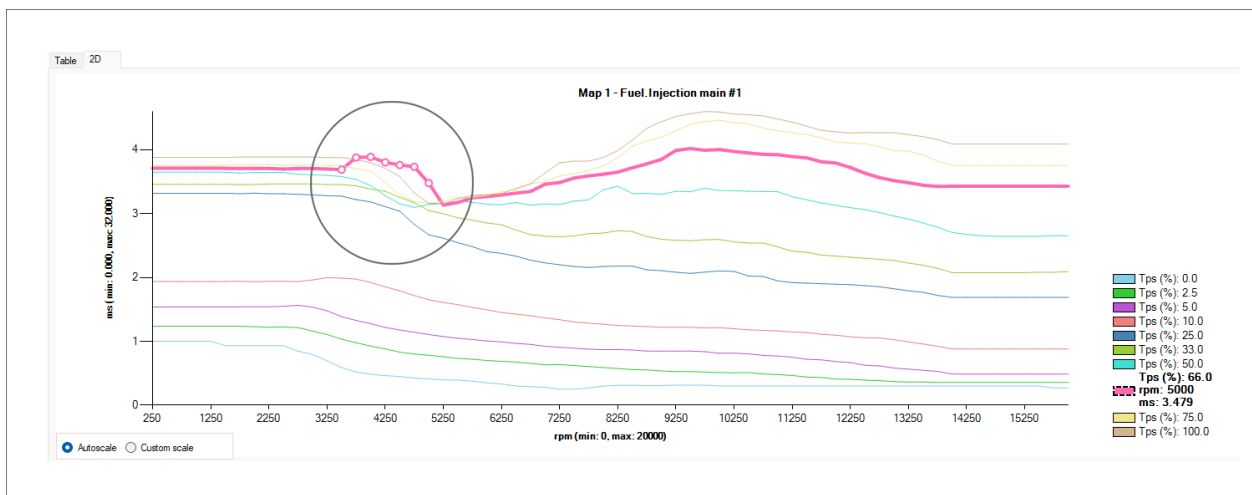

6.5.4 – 2D Format

Select 2D layer and you can move among the lines using the arrow keys (keyboard).

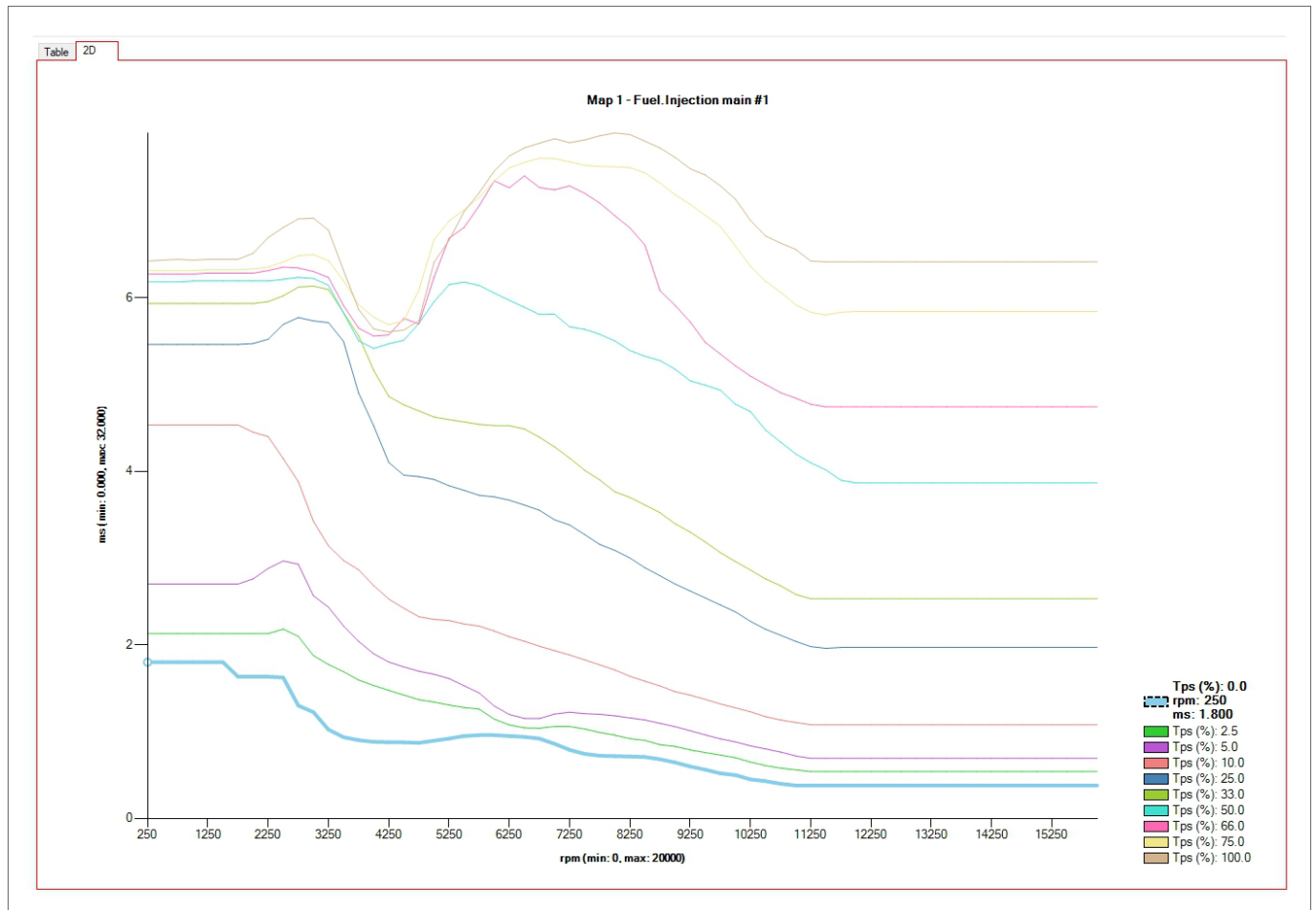

Once the desired point selected you can modify the graph using the keyboard:

- Ctrl+Up -> Increase the selected entries for entry resolution (+ 0,1 per pressure)
- Ctrl+Down -> Decrease the selected entries for entry resolution (+ 0,1 per pressure)
- Alt+Up -> Increase the selected entries for entry resolution.
- Alt+Down -> Decrease the selected entries for entry resolution.

Once data in 2D graph changed, **to write them into the ECU** come back to Table view and press the Enter Key.

To focus on a particular line, click the line and press the shortcut "Ctrl+Q". This hides the other lines. Use "Ctrl+W" to unhide them.

Default graph setting is Auto scale but It is also possible to set custom scale. To do so enable the related checkbox, click the setting icon and fill in the panel that is prompted: the graph is shown in custom scale (bottom graph in the image below).

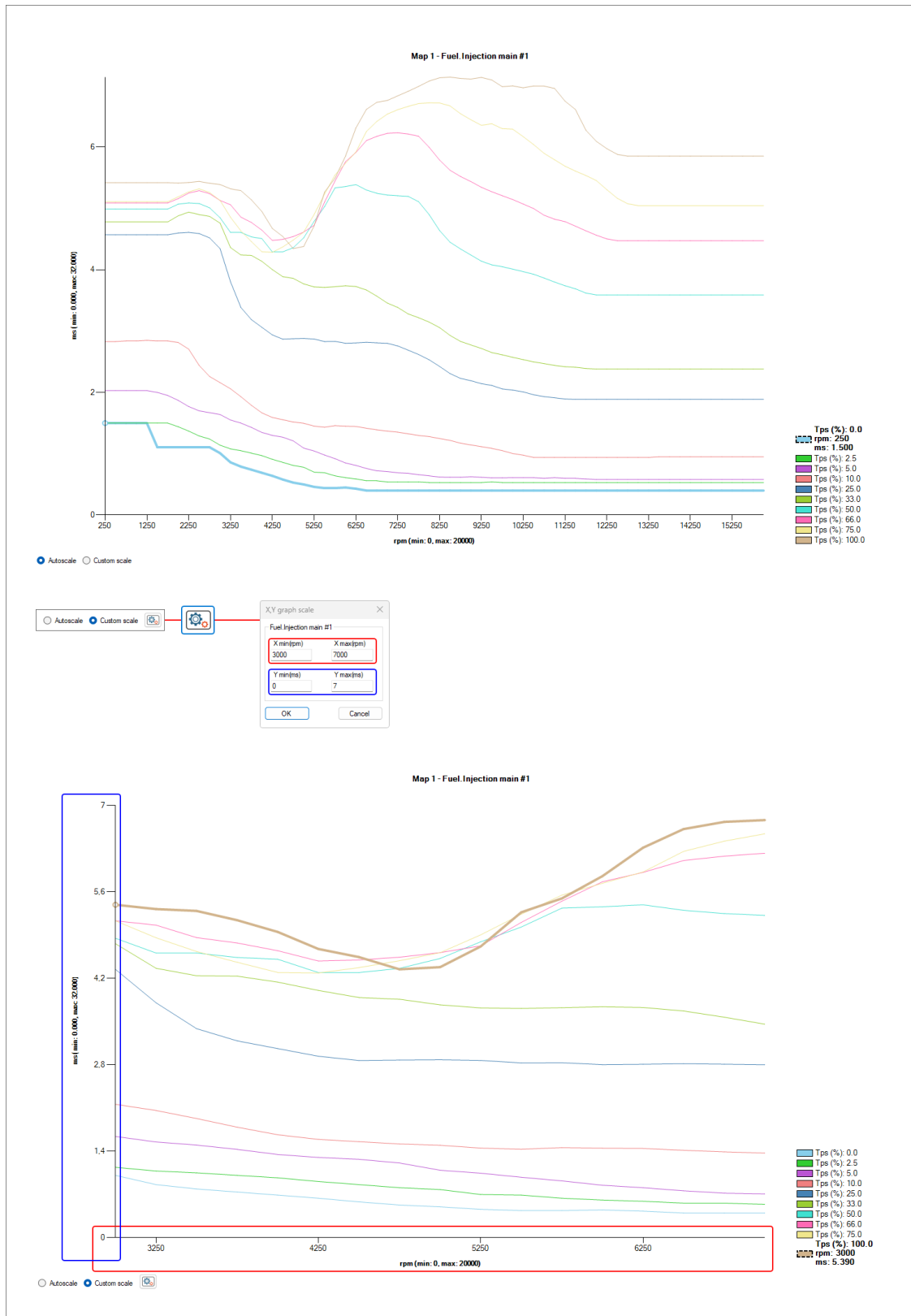

6.6 – Live measures panel

Live measures panel is shown bottom of the software main page. To make it showing live measures you need to:

- ensure Taipan ECU is plugged and connected to the PC
- press “Start Live Measures” icon
- press “Show Live Measures Panel” icon

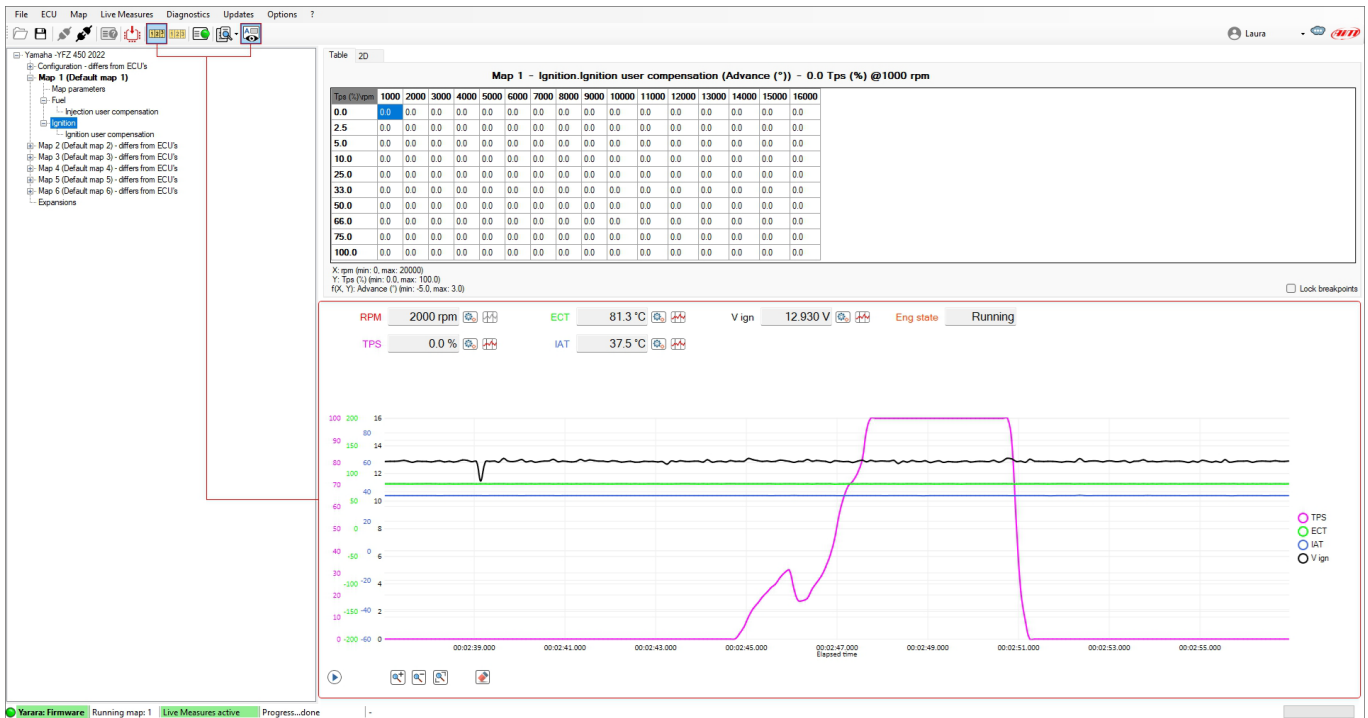

Live Measures panel available measures changes according to the software licence you have. With User license available measures are:

- **ECT:** Engine coolant temperature
- **IAT:** Intake air temperature
- **V ign:** Motorcycle ignition voltage
- **λ:** Lambda values (only available if Taipan is connected to an AiM logger in turn connected to LCU1 Lambda controller)
- **RPM:** current Round Per Minute value
- **TPS:** current Throttle position sensor percentage value
- **Eng state:** Engine state

6.7 – Info bar

The bottom bar is “Info” bar, where you can quickly monitor ECU-software communication state.

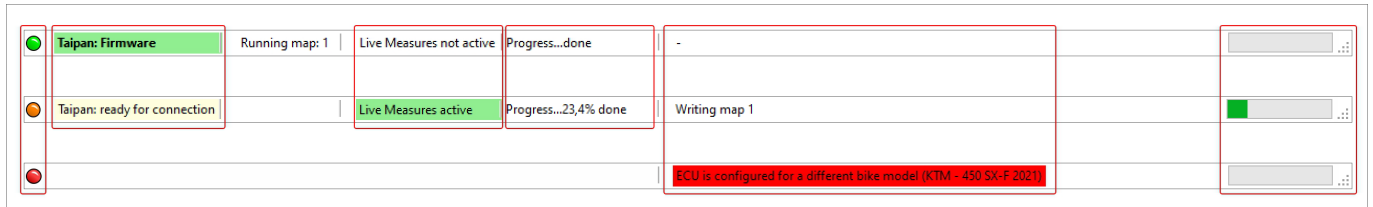

From left to right:

- LED indicating Taipan status:
 - green: ECU recognised
 - orange blinking: ECU is being recognized
 - red: ECU not recognized
- Taipan connection:
 - firmware: Taipan connected
 - ready for connection
 - not connected: in this case you cannot write or flash any thing in the ECU
- Running Map “x”: shows the map number that is running on Taipan (1 in the example above)
- Live Measures:
 - active
 - not active
- Operation progress:
 - done
 - progress %
- Status bar:
 - none: no operation is being performed
 - writing map “x”: shows the map that is being written in Taipan
- ECU is configured for a different bike model: this happens when you open a different configuration from the one written in the ECU; **please remember that once you flashed a configuration in Taipan you have 24 hours to change the configuration afterwards the configuration cannot be changed anymore.**



Appendix A – AiM ECUs and accessories part numbers

- | | |
|---------------------|------------------|
| • Taipan ECU | XE1ECUCB0 |
| • Taipan Y ECU | XE1ECUCB1 |
| • Yarara ECU | XE1ECUYA0 |
| • UC Bridge user | XE1UCB000 |
| • Handle Bar Switch | XE1HBS000 |

Additional cables or harnesses are also available

- | | |
|--|------------------|
| • All ECUs 2m extension cable | V02596020 |
| • All ECUs 4m extension cable | V02596030 |
| • 50cm extension cable for connection with Solo 2 DL | V02589120 |
| • Analog channels and second injection harness | V02596060 |
| • Analog channels harness | V02596070 |
| • Second Injection harness | V02596080 |
| • Yarara additional harness | V02596090 |

Appendix B – AiM ECUs and accessories dimensions and pinout

Taipan/Taipan Y dimensions in mm [inches]

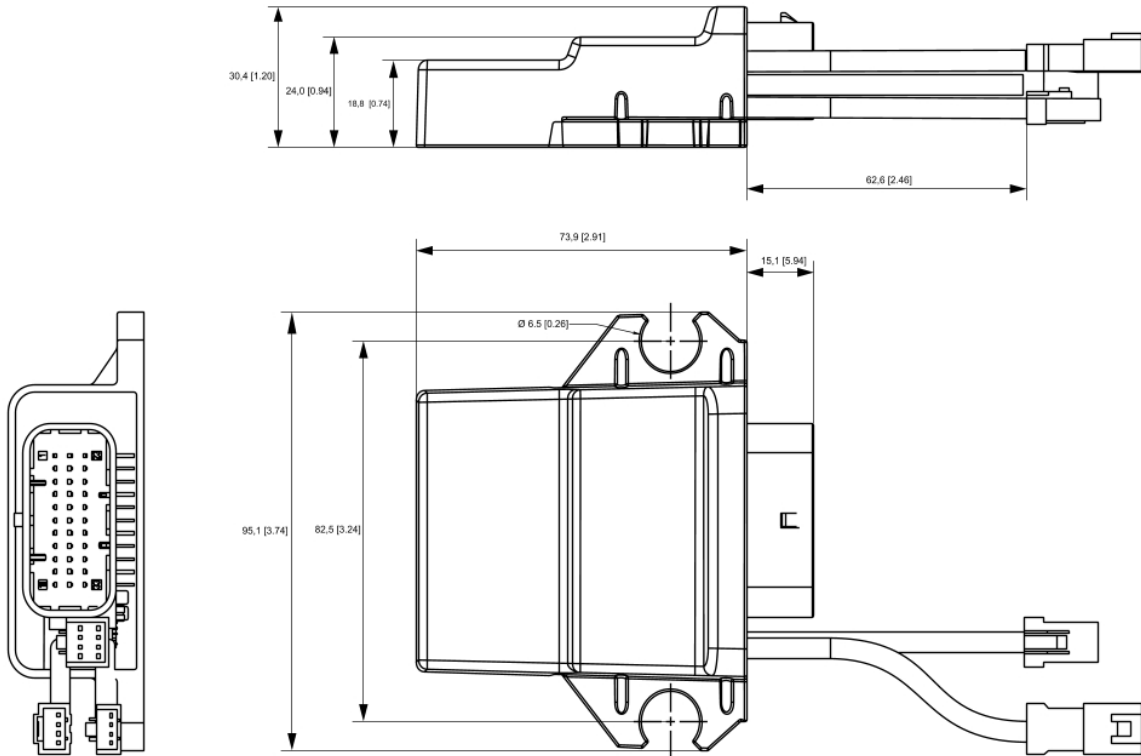

Taipan Y v2 dimensions in mm [inches]

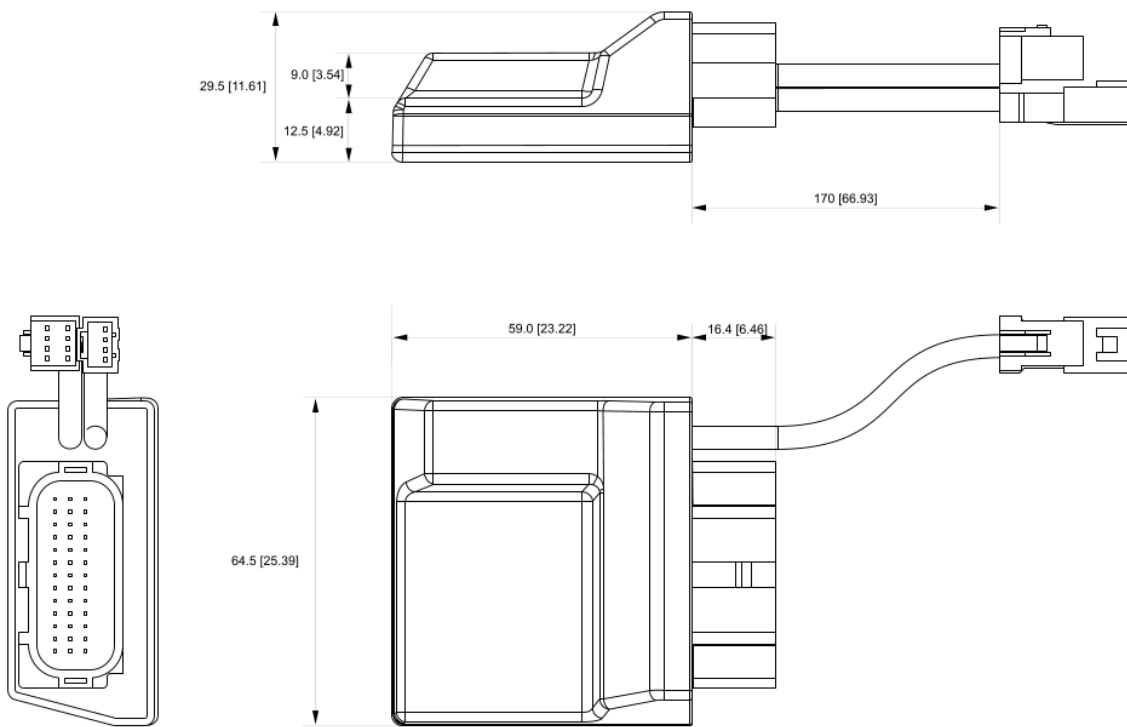



Taipan K dimensions in mm [inches]

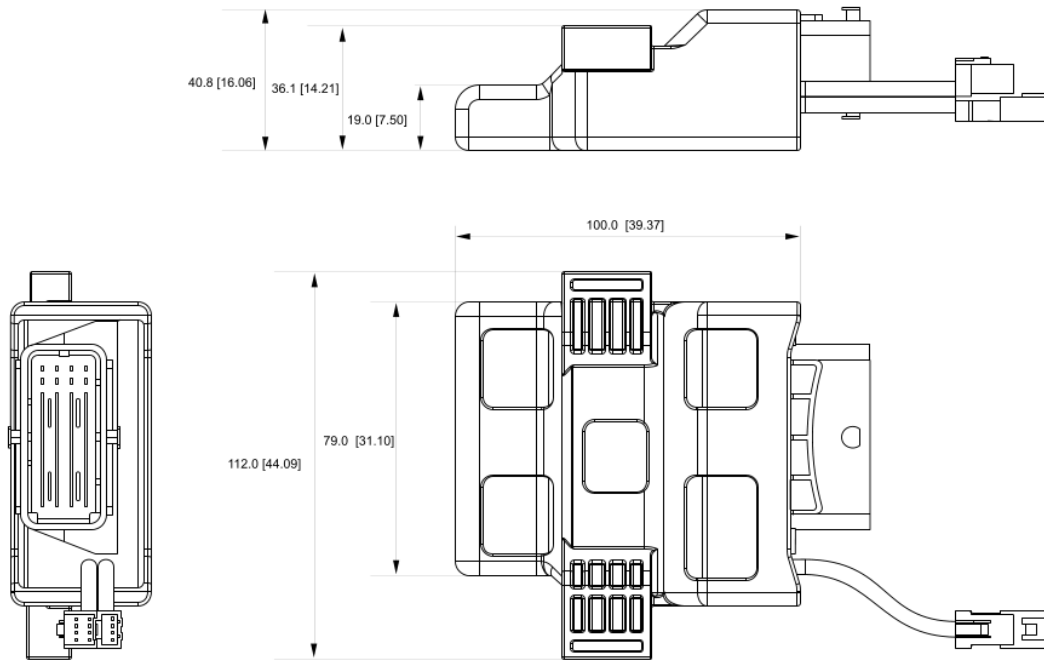

Yarara dimensions in mm [inches]

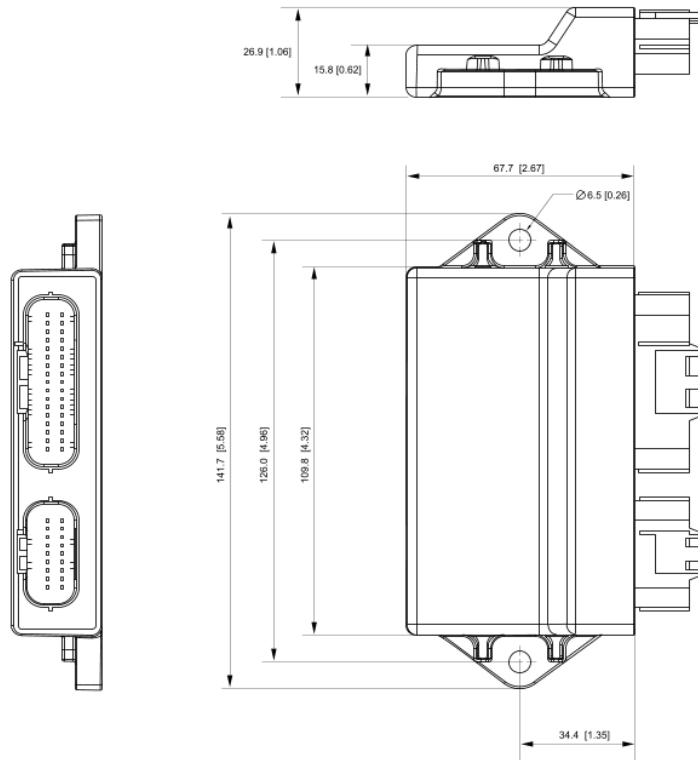

Handlebar switch dimensions in mm [inches]

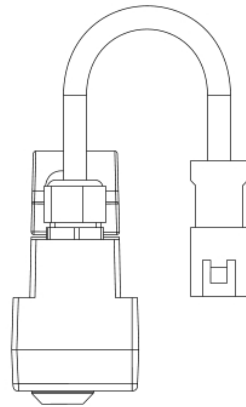
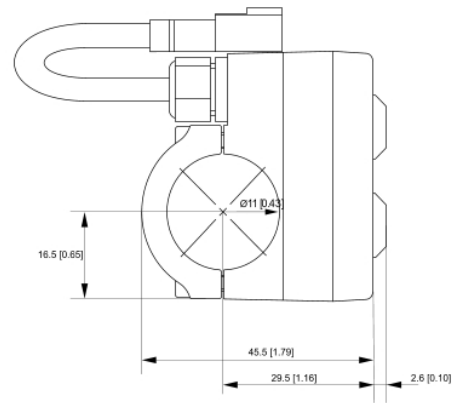
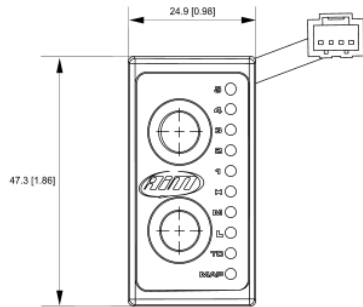



UC Bridge dimensions in mm [inches]

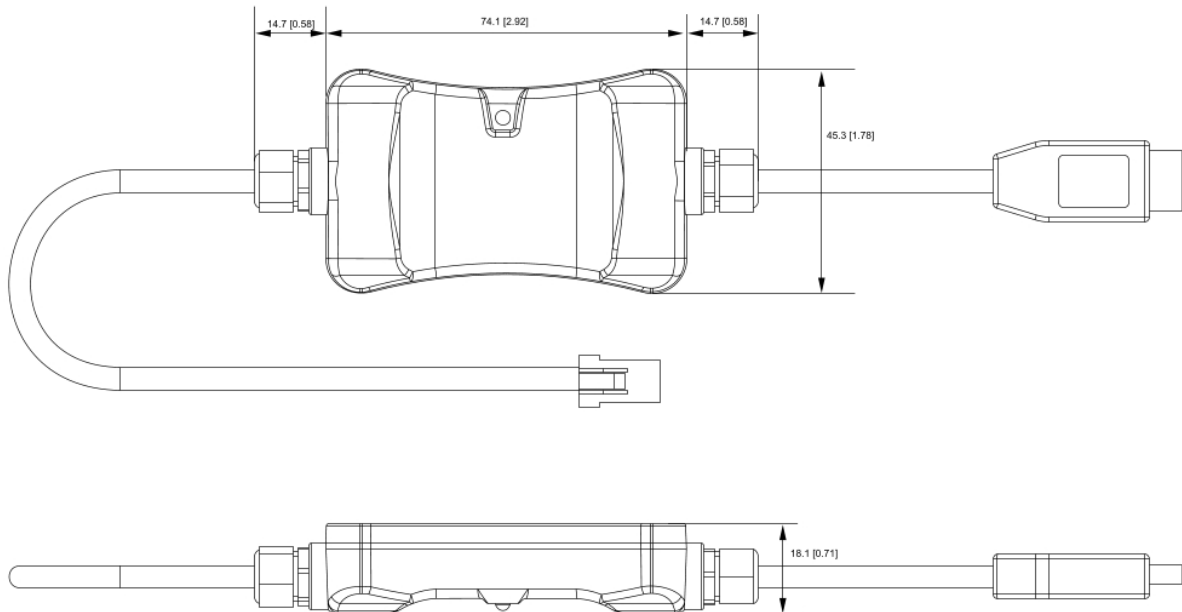

Taipan pinout

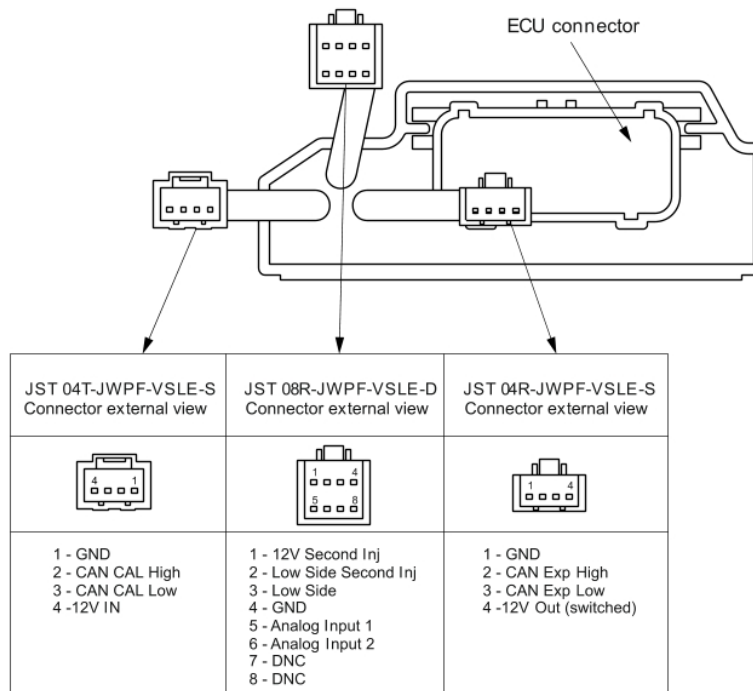

Taipan Y Pinout

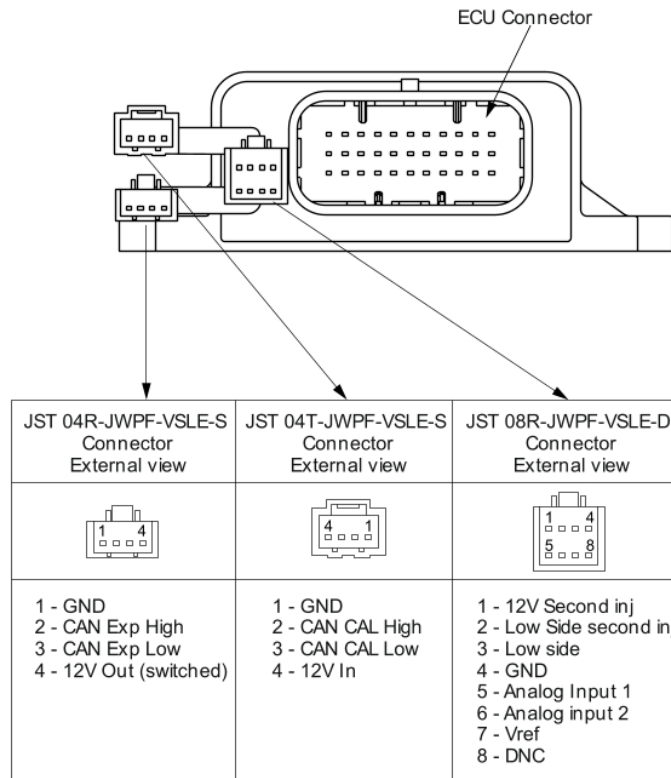

Taipan Y v2 pinout

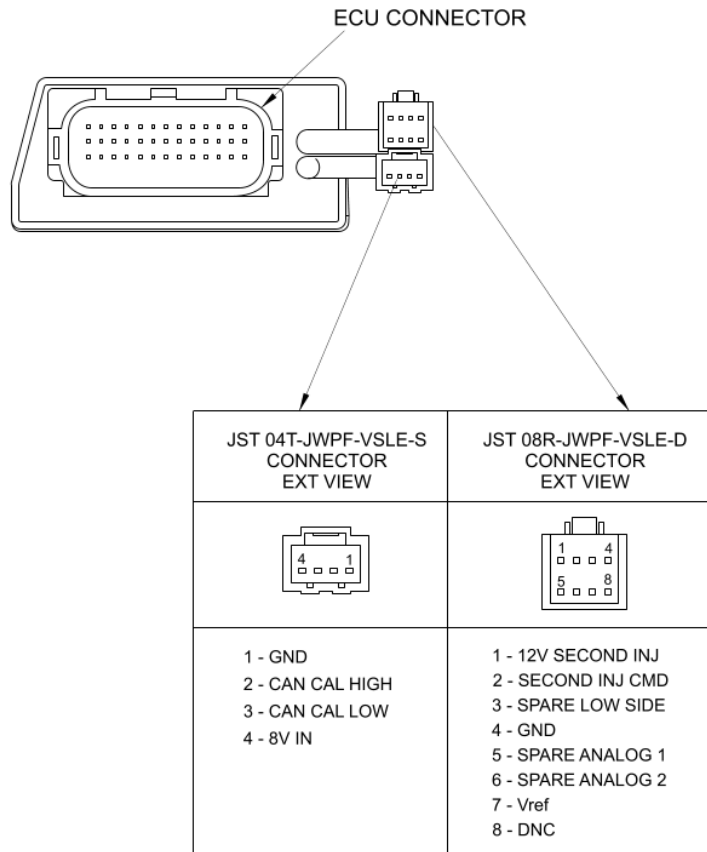

Taipan K Pinout

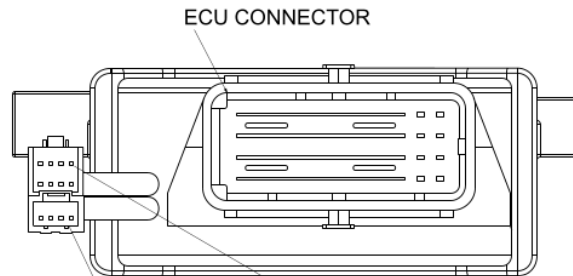

| JST 04T-JWPF-VSLE-S CONNECTOR EXT VIEW | JST 08R-JWPF-VSLE-D CONNECTOR EXT VIEW |
|---|---|
| | |
| 1 - GND 2 - CAN CAL HIGH 3 - CAN CAL LOW 4 - 8V IN | 1 - +12V OUT 2 - DNC 3 - SPARE LOW SIDE 4 - GND 5 - SPARE ANALOG 1 6 - SPARE ANALOG 2 7 - Vref 8 - DNC |

Yarara pinout

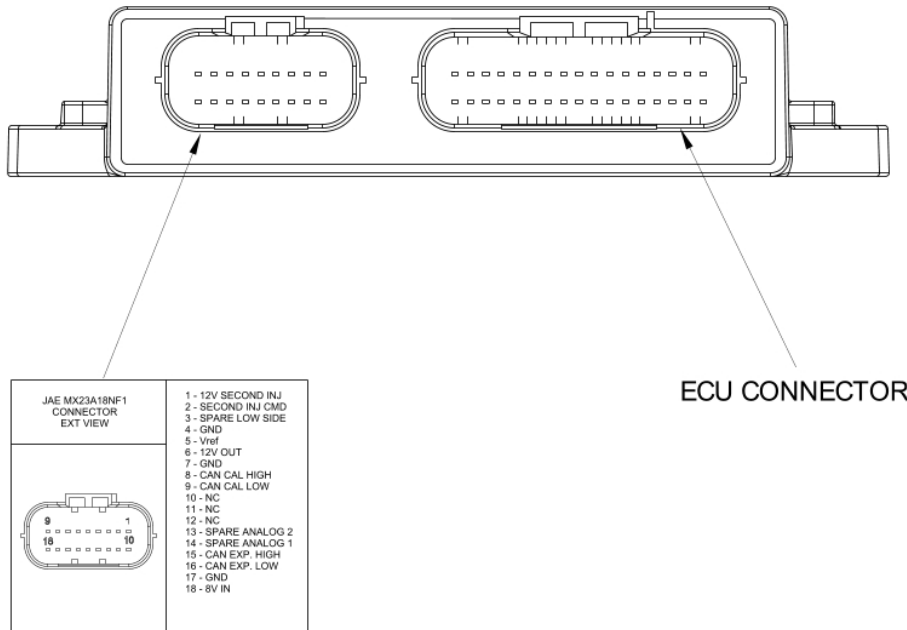

Handlebar switch pinout

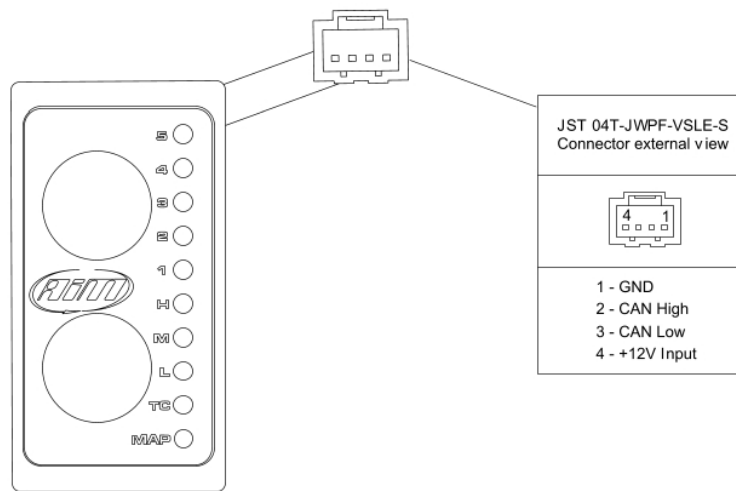

UC Bridge pinout

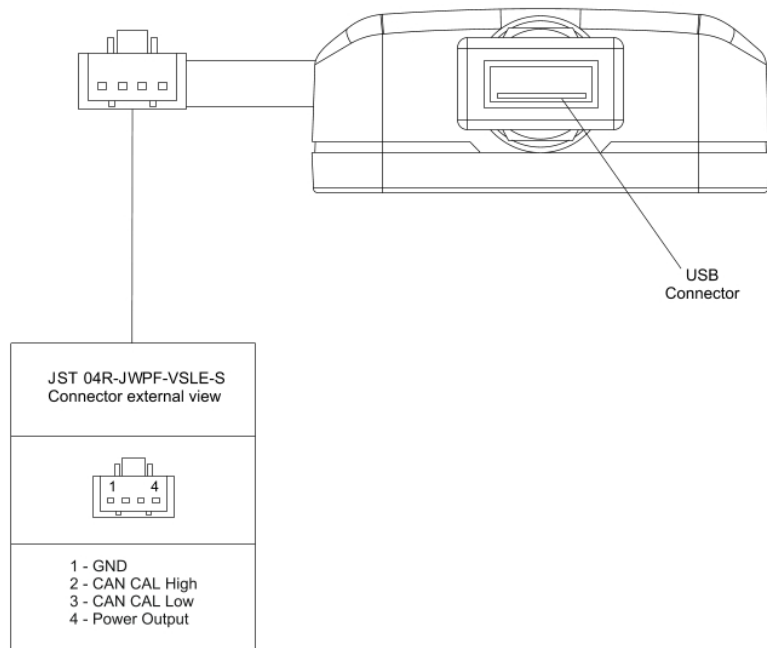

Appendix C – Taipan and Yarara harnesses

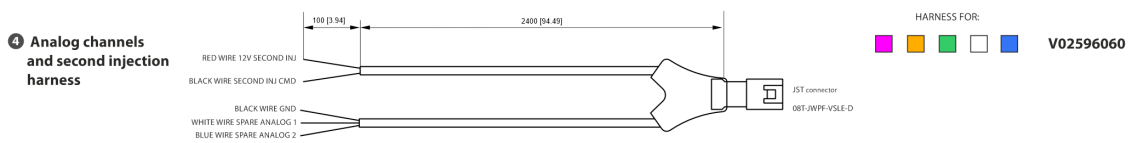
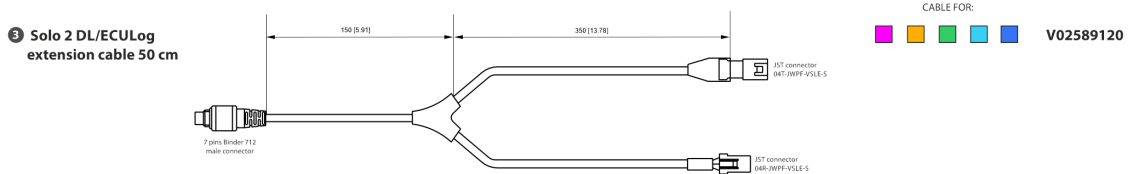
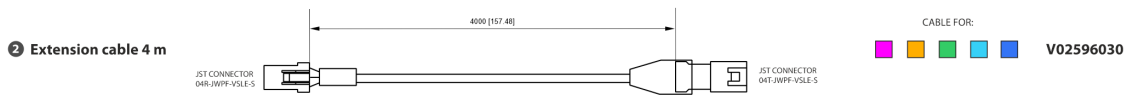
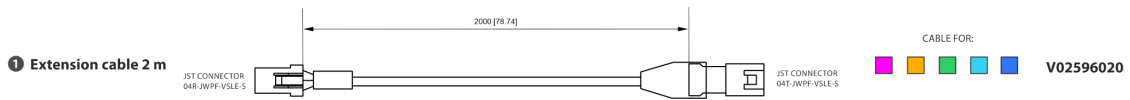

- Taipan
- Taipan Y
- Taipan Y v2
- Taipan K
- Yarara

Dimensions in mm [inches]



5 Analog channels harness

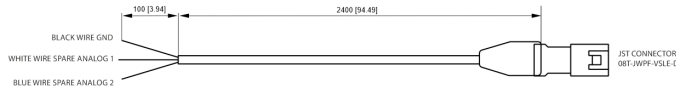

CABLE FOR: ■ ■ ■ ■ ■ **V02596070**

6 Second injection harness

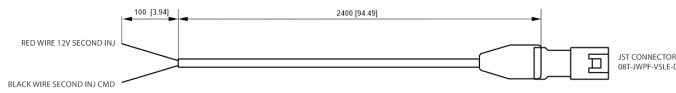

CABLE FOR: ■ ■ ■ ■ ■ **V02596080**

7 CAN + EXT Power harness for Taipan Y v2

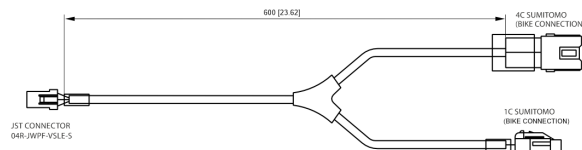

CABLE FOR: ■ ■ ■ ■ ■ **V02596140**

8 CAN + EXT Power Taipan K cable

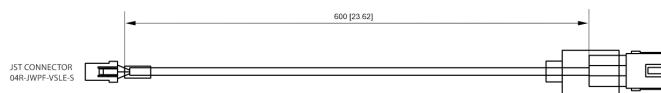

HARNESS FOR: ■ ■ ■ ■ ■ **V02596160**

- Taipan
- Taipan Y
- Taipan Y v2
- Taipan K
- Yarara

Dimensions in mm [inches]

9 Solo 2 DL/ECUlog CAN + EXT power Taipan K cable

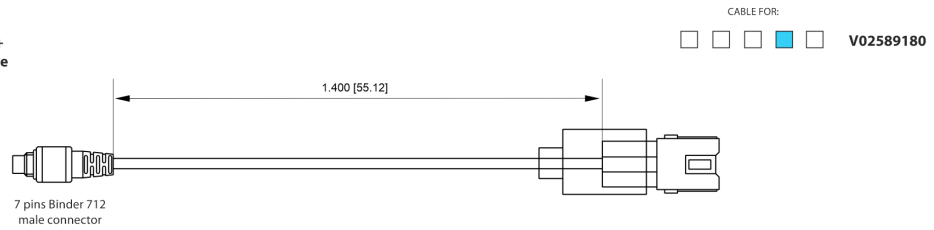

10 Additional harness for ECU Yarara

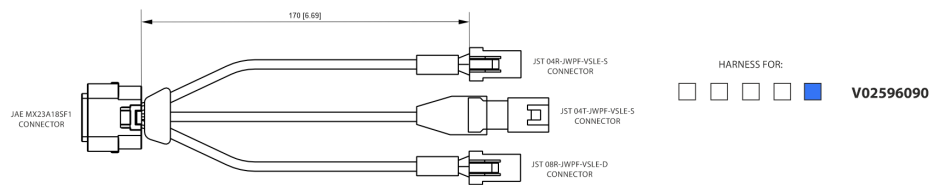

- Taipan
- Taipan Y
- Taipan Y v2
- Taipan K
- Yarara

Dimensions in mm [inches]

Yarara optional cable pinout

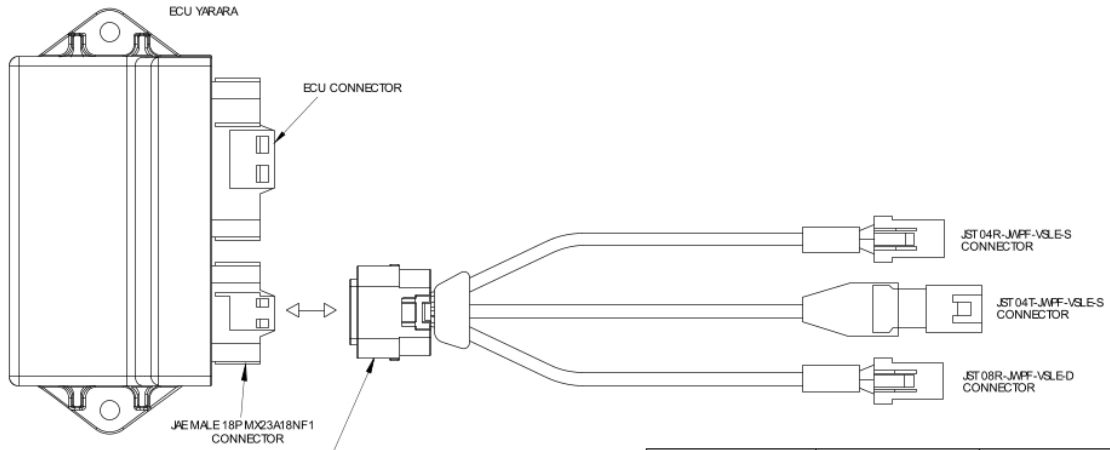

| JAE MX23A18NF1 CONNECTOR EXT VIEW | |
|-----------------------------------|---|
| | 1 - 12V SECOND INJ 2 - SECOND INJ CMD 3 - SPARE LOWSIDE 4 - GND 5 - Vref 6 - 12V OUT 7 - GND 8 - CAN CAL HIGH 9 - CAN CAL LOW 10 - NC 11 - NC 12 - NC 13 - SPARE ANALOG 2 14 - SPARE ANALOG 1 15 - CAN EXP HIGH 16 - CAN EXP LOW 17 - GND 18 - 8V IN |

| JST 04R-JWPF-VSLE-S CONNECTOR EXT VIEW | JST 04T-JWPF-VSLE-S CONNECTOR EXT VIEW | JST 08R-JWPF-VSLE-D CONNECTOR EXT VIEW |
|---|--|--|
| | | |
| 1 - GND 2 - CAN EXP HIGH 3 - CAN EXP LOW 4 - 12V OUT | 1 - GND 2 - CAN CAL HIGH 3 - CAN CAL LOW 4 - 8V OUT | 1 - 12V SECOND INJ 2 - SECOND INJ CMD 3 - SPARE LOWSIDE 4 - GND 5 - SPARE ANALOG 1 6 - SPARE ANALOG 2 7 - Vref 8 - NC |

AiM ECUs CAN+External power cable for Solo 2 DL dimensions and pinout

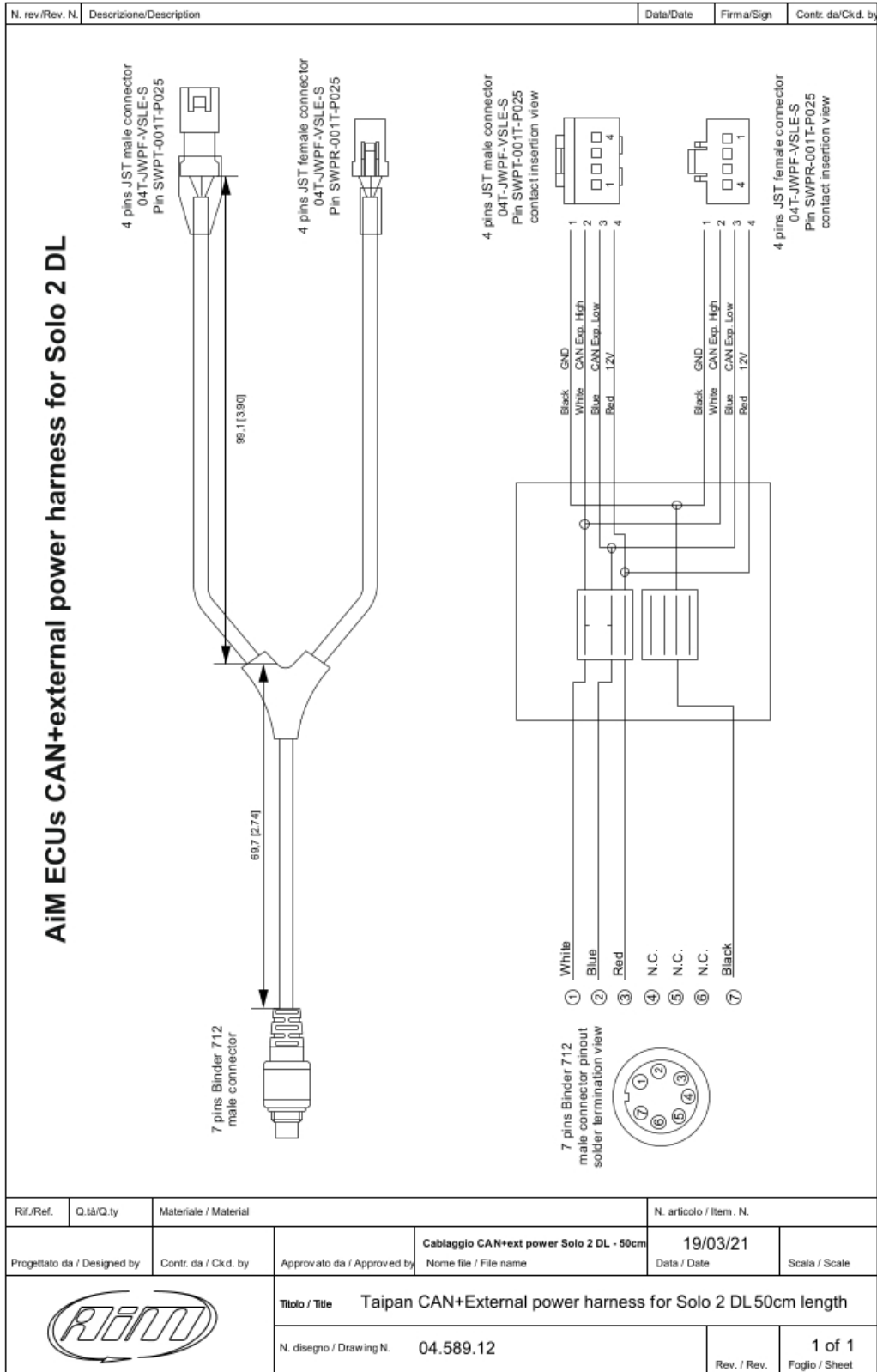



Appendix E – Dictionary

Here you find a list of the terminology used in this manual and relevant to the Spark software.

Configuration: a Configuration includes the base parameters not directly related to the engine performance, i.e.:

- Set up parameters for the map switch like fuel correction, threshold of RPM to activate the correction chosen.
- Set up strategies (Quickshift).
- Set up the VB out (Voltage Battery Output).
- Set up the Can configuration.

Map: the combination of all the parameters managed by the ECU directly related to engine performance and it consists in different tables.

Project: the union of ECU configuration and ECU Maps.

Write: means that the data are sent real time to the ECU, but not stored in it. As soon as this is turned off, data “written” are cleared. Generally used to tune some entries live.

Flash: data are sent in real time to the ECU and stored in a permanent memory. Generally used to write a complete map.

TPS: Throttle Position Sensor in %.

ECT: Engine Coolant Temperature.

MAP: Manifold Air Pressure.

BARO: Barometric Air Pressure.

EWT: Engine Water Temperature.

IAT: Intake Air Temperature.

VIGN: Ignition Voltage in V.

Valid Map: A map may be not valid in these situations:

- if not completely transmitted to the ECU
- if not compatible with the ECU firmware version.

Running Map: the map the ECU is actually using.



Appendix D – Malfunctioning Indicator Lamp (MIL) – Taipan only

From Taipan firmware version 0.5.19 all bikes equipped with a MIL (Malfunction indicator Lamp) a visual indicator of malfunctions is available. According to the settings here below explained the type of error will be identified:

- 1 Flash → Primary Injector Failure
- 2 Flashes → Secondary Injector Failure (stock on the bikes that feature it)
- 3 Flashes → MAP (manifold air pressure) sensor failure
- 4 Flashes → TPS (throttle position sensor) sensor failure
- 5 Flashes → ECT (engine coolant temperature) sensor failure
- 6 Flashes → IAT (Intake air temperature) sensor failure
- 7 Flashes →GEAR sensor (where available) failure