

Kit AiM Solo/SoloDL for Yamaha R1-R6 2004-2013

Installation guide

Fig. 1/9

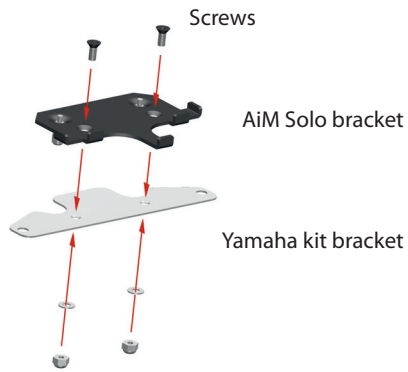

Fix Solo bracket to Yamaha kit bracket

Fig. 2/9



Hook Solo to its housing

Fig. 3/9

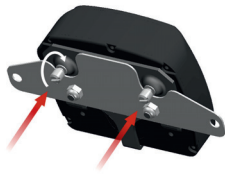

Fix Solo using the proper screws

Fig. 4/9

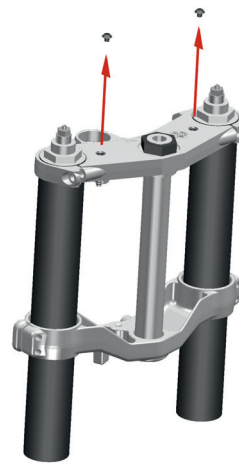

Remove screw caps from the bike

Fig. 5/9

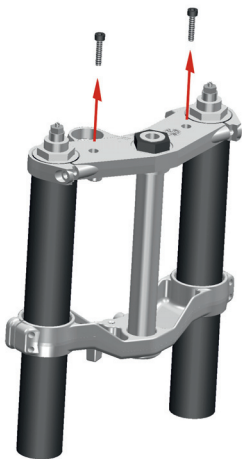

Remove the original screws that lock the handlebars to the top plate

Fig. 6/9

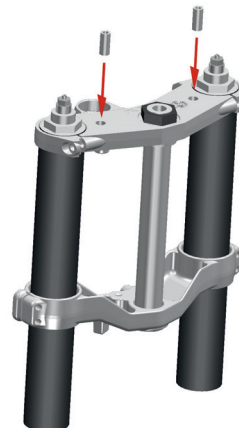

Insert the cylindrical distance pieces in the screws housings

Kit AiM Solo/SoloDL for Yamaha R1-R6 2004-2013

Installation guide

Fig. 7/9

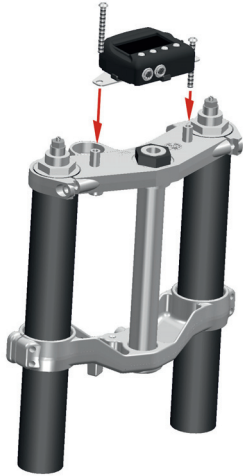

Place Solo plate with external holes in line with the distance pieces and insert the screws you find in the kit firmly screwing them (if your handlebars are original)

Fig. 8/9



Fig. 9/9

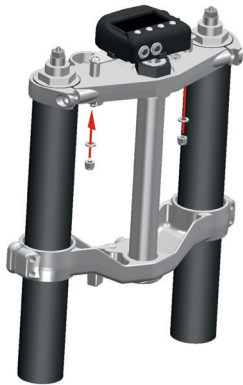

If your handlebars are not original, lock the bolts with the nuts you find in the kit