



SmartyCam 3 GP

On-board camera



SMARTYCAM 3 GP
MODULE

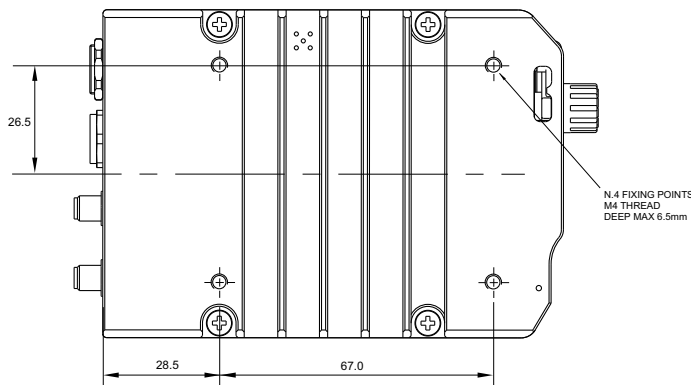

SMARTYCAM 3 GP
BULLET CAM 120°

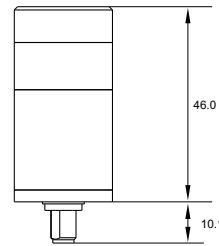

SMARTYCAM 3 GP
BULLET CAM 67°- 84°

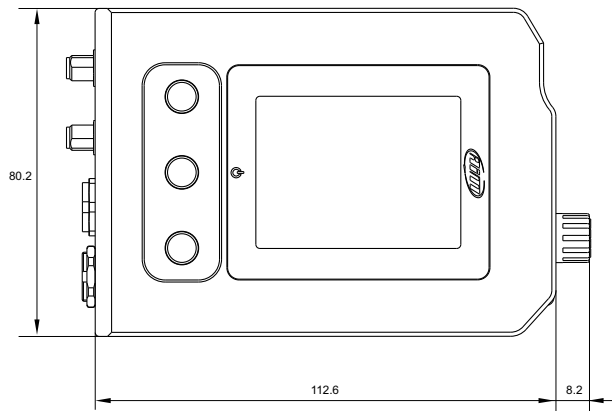
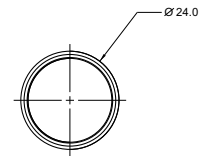
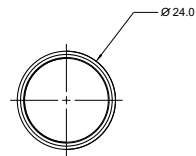
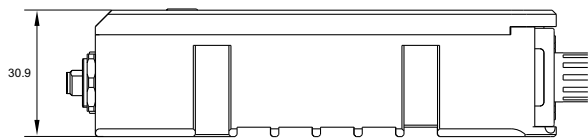
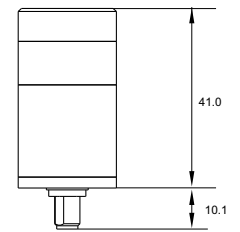



SmartyCam 3 GP

On-board camera

Pinout

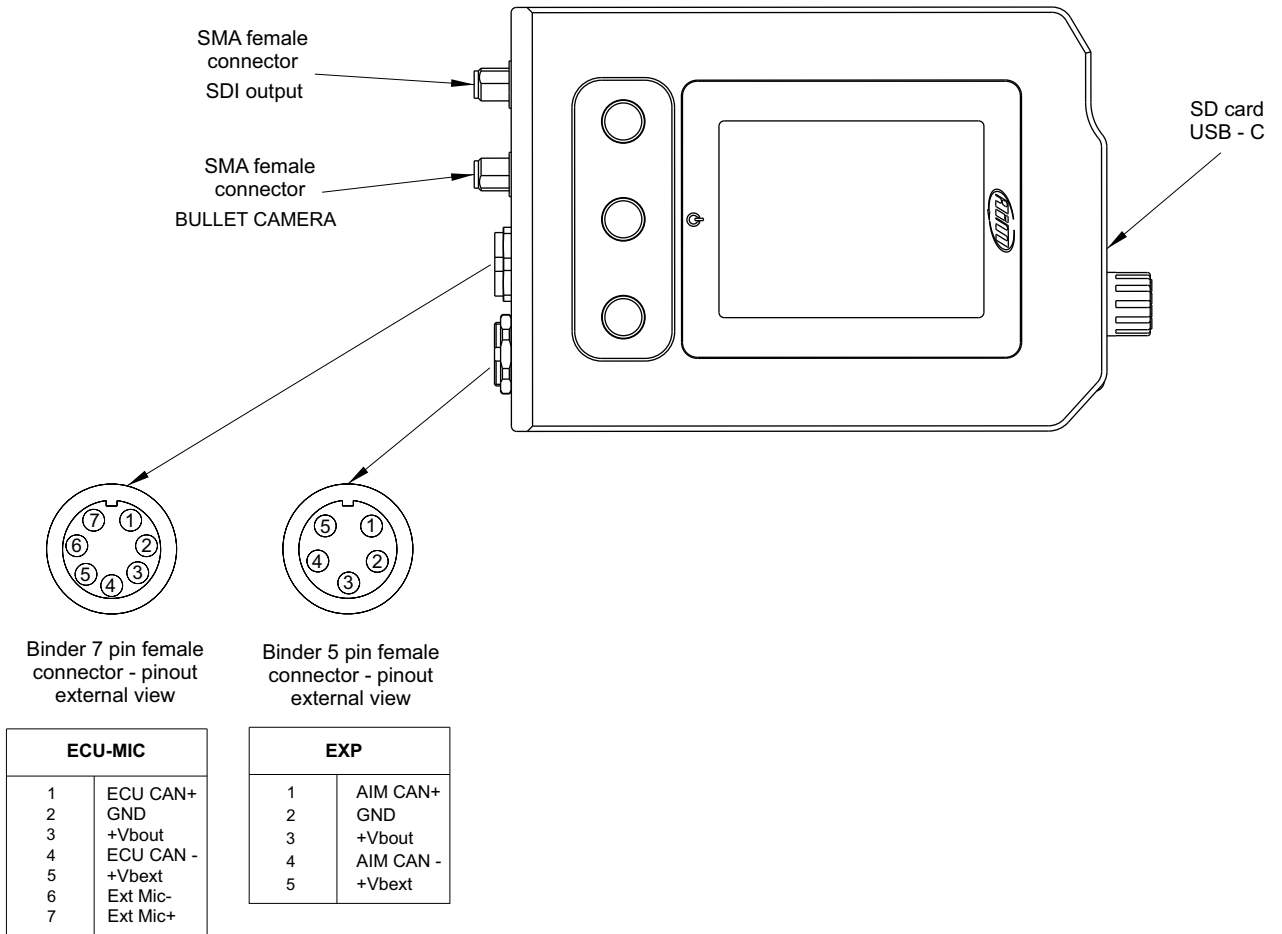



SmartyCam 3 GP

On-board camera

Technical characteristics

Video format	H.264 1920 x 1080 pixels @ 60 fps
Display resolution	2.4" 240 x 320 pixels
Lens	Low distortion camera lens
CMOS sensor	Global Shutter
Field of view	67°, 84° or 120°
Internal battery	Rechargeable lithium battery
Video Out	3G-SDI
External power	9-15 Volt
Supported SD card	Up to 2 TB
Usage temperatures	-10°C/+50°C
Auto Power ON	Yes
Auto Power OFF	Yes
Auto Start/Stop Recording	Yes
Body	Anodized Aluminum
Dimensions	Main unit 120.8 x 80.2 x 30.9 mm Bullet camera 24 diam x 46.0 mm (120° lens) Bullet camera 24 diam x 41.0 mm (67°-84° lens)
Connectors	2 Binder 712 female connectors + 2 SMA female connector (see pinout page) + 1 USB-C
Bullet cable length	From 0.5 m to 4 m (7 lengths available)
Weight	Main unit 320 g Bullet 45 g
Waterproof	IP65









SmartyCam 3 GP







On-board camera

Kits, accessories & spare parts







Kit 1 SmartyCam 3 GP 67° lens CAN 2 m

Description	Part number*	The kit contains					
SmartyCam 3 GP Kit with bullet cam 67° + CAN Exp. cable 2 m	XS3GPFHD067L200 □	SmartyCam 3 GP Module	Bullet cam 67°	Battery charger with AC adapter	Bullet cam cable 2 m	CAN Expansion cable 2 m	USB 2.0 Type A cable
							







Kit 2 SmartyCam 3 GP 67° lens CAN 4 m

Description	Part number*	The kit contains					
SmartyCam 3 GP Kit with bullet cam 67° + CAN Exp. cable 4 m	XS3GPHFD067L201 □	SmartyCam 3 GP Module	Bullet cam 67°	Battery charger with AC adapter	Bullet cam cable 2 m	CAN Expansion cable 4 m	USB 2.0 Type A cable
							

Kit 3 SmartyCam 3 GP 84° lens CAN 2 m

Description	Part number*	The kit contains					
SmartyCam 3 GP Kit with bullet cam 84° + CAN Exp. cable 2 m	XS3GPFHD084L200 □	SmartyCam 3 GP Module	Bullet cam 84°	Battery charger with AC adapter	Bullet cam cable 2 m	CAN Expansion cable 2 m	USB 2.0 Type A cable
							

Kit 4 SmartyCam 3 GP 84° lens CAN 4 m

Description	Part number*	The kit contains					
SmartyCam 3 GP Kit with bullet cam 84° + CAN Exp. cable 4 m	XS3GPHFD084L201 □	SmartyCam 3 GP Module	Bullet cam 84°	Battery charger with AC adapter	Bullet cam cable 2 m	CAN Expansion cable 4 m	USB 2.0 Type A cable
							

* AC Adapter: substitute □ with:

- E** for Europe
- G** for UK
- U** for USA
- A** for Australia









SmartyCam 3 GP







On-board camera

Kits, accessories & spare parts

Kit 5 SmartyCam 3 GP 120° lens CAN 2 m

Description	Part number*	The kit contains					
SmartyCam 3 GP Kit with bullet cam 120° + CAN Exp. cable 2 m	XS3GPFHD120L200 □	SmartyCam 3 GP Module	Bullet cam 120°	Battery charger with AC adapter	Bullet cam cable 2 m	CAN Expansion cable 2 m	USB 2.0 Type A cable
							



Kit 6 SmartyCam 3 GP 120° lens CAN 4 m

Description	Part number*	The kit contains					
SmartyCam 3 GP Kit with bullet cam 120° + CAN Exp. cable 4 m	XS3GPHFD120L201 □	SmartyCam 3 GP Module	Bullet cam 120°	Battery charger with AC adapter	Bullet cam cable 2 m	CAN Expansion cable 4 m	USB 2.0 Type A cable
							

* AC Adapter: substitute □ with:

- E** for Europe
- G** for UK
- U** for USA
- A** for Australia

Optionals/Spare Parts

Description	Part number	
SmartyCam 3 GP Module	XS3GPFHD00	
Bullet Cams	Part number	
Bullet cam 67°	XS3B06700	
Bullet cam 84°	XS3B08400	
Bullet cam 120°	XS3B12000	
Bullet Cam Cables	Part number	
0.5 m	V02584190	
1 m	V02584180	
1.5 m	V02584170	
2 m	V02566980	
2.5 m	V02584220	
3 m	V02584160	
4 m	V02584070	











SmartyCam 3 GP

On-board camera

Kits, accessories & spare parts

Optionals/Spare Parts

CAN ECU cables	Part number	
CAN ECU cable 2 m	V02566930	
CAN ECU cable 4 m	V02566940	
CAN ECU cable + Jack 2 m	V02584140	
CAN ECU cable + Jack 4 m	V02584150	
Jack cable 1 m	V02584040	
CAN Exp. cables	Part number	
CAN Expansion cable 2 m	V02554820	
CAN Expansion cable 4 m	V02554830	
Other cables	Part number	
USB 2.0 Type A cable	X90TMPC101010	
Battery charger with AC adapter	Part number	
AC Adapter: substitute □ with E for Europe, G for UK, U for USA, A for Australia	X06A12VBM□	







SmartyCam 3 GP

On-board camera

Kits, accessories & spare parts

Optionals/Spare Parts

Bracket kits for record unit	Part number	
Roll-bar kit In the box: handlebar bracket, 90 mm arm, clamp base with ball, mounting bracket, locknuts, washers and screws	X90KSGPRB	
U-bolt kit In the box: U-bolt, 90 mm arm, clamp base with ball, mounting bracket, locknuts, washers and screws	X90KSGPTP	
Suction cup In the box: suction cup, 90 mm arm, clamp base with ball, mounting bracket, locknuts, washers and screws	X90KSGPVS	
Bracket kits for bullet cams	Part number	
Roll-bar kit In the box: handlebar bracket, 60 mm arm, ball head, bullet-cam bracket	X90KSBLRB	
U-bolt kit In the box: U-bolt, 60 mm arm, ball head, bullet-cam bracket	X90KSBLTP	
Suction cup In the box: suction cup, 60 mm arm, ball head, bullet-cam bracket	X90KSBLV0	