

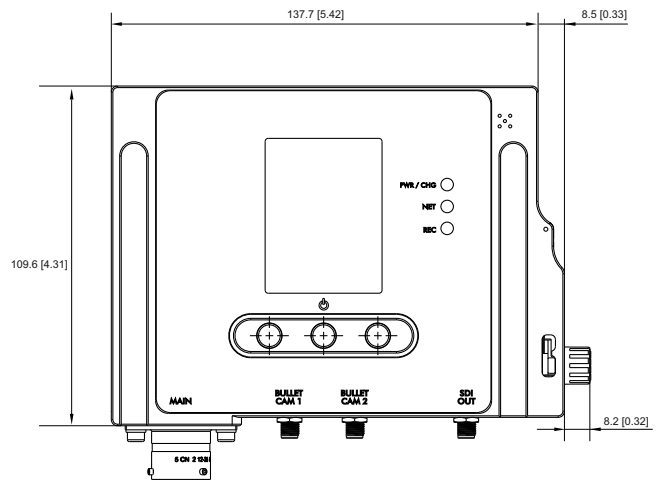

SmartyCam 3 Dual

On-board camera with bullet cams

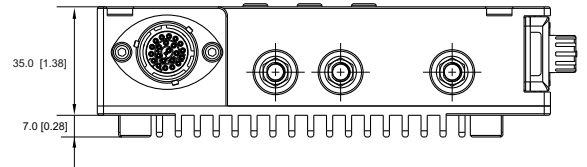

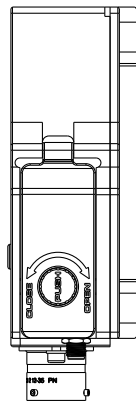
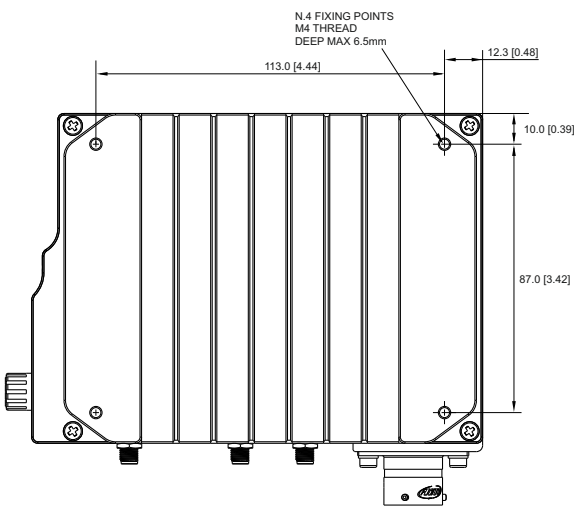
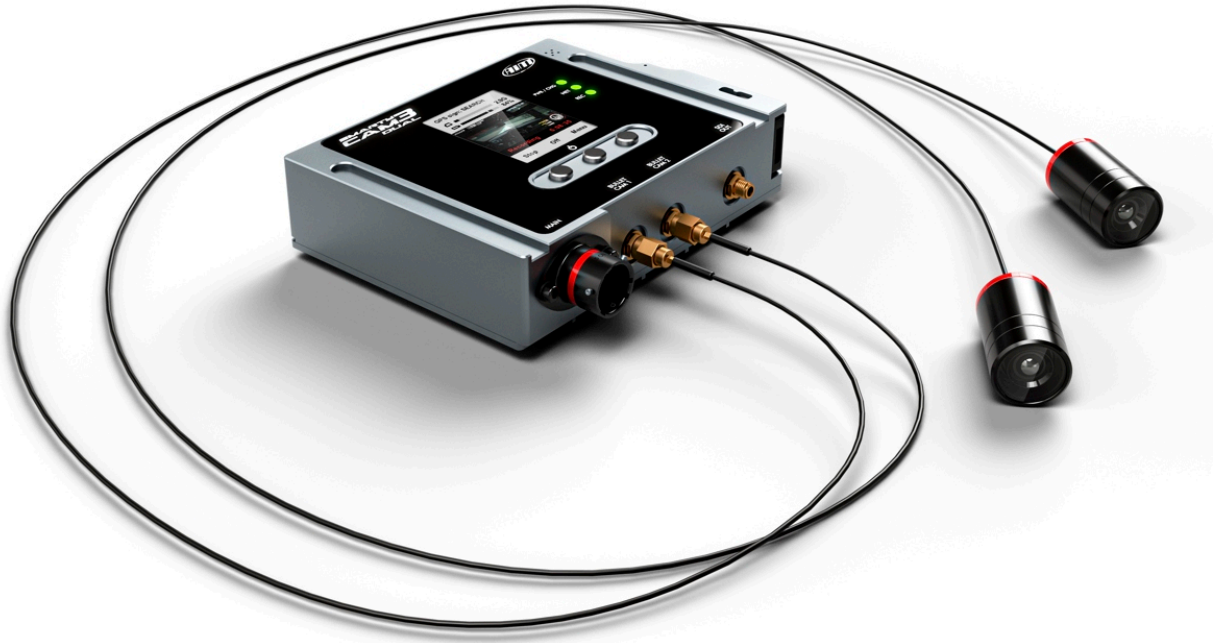

SmartyCam 3 Dual

On-board camera with bullet cams

Pinout

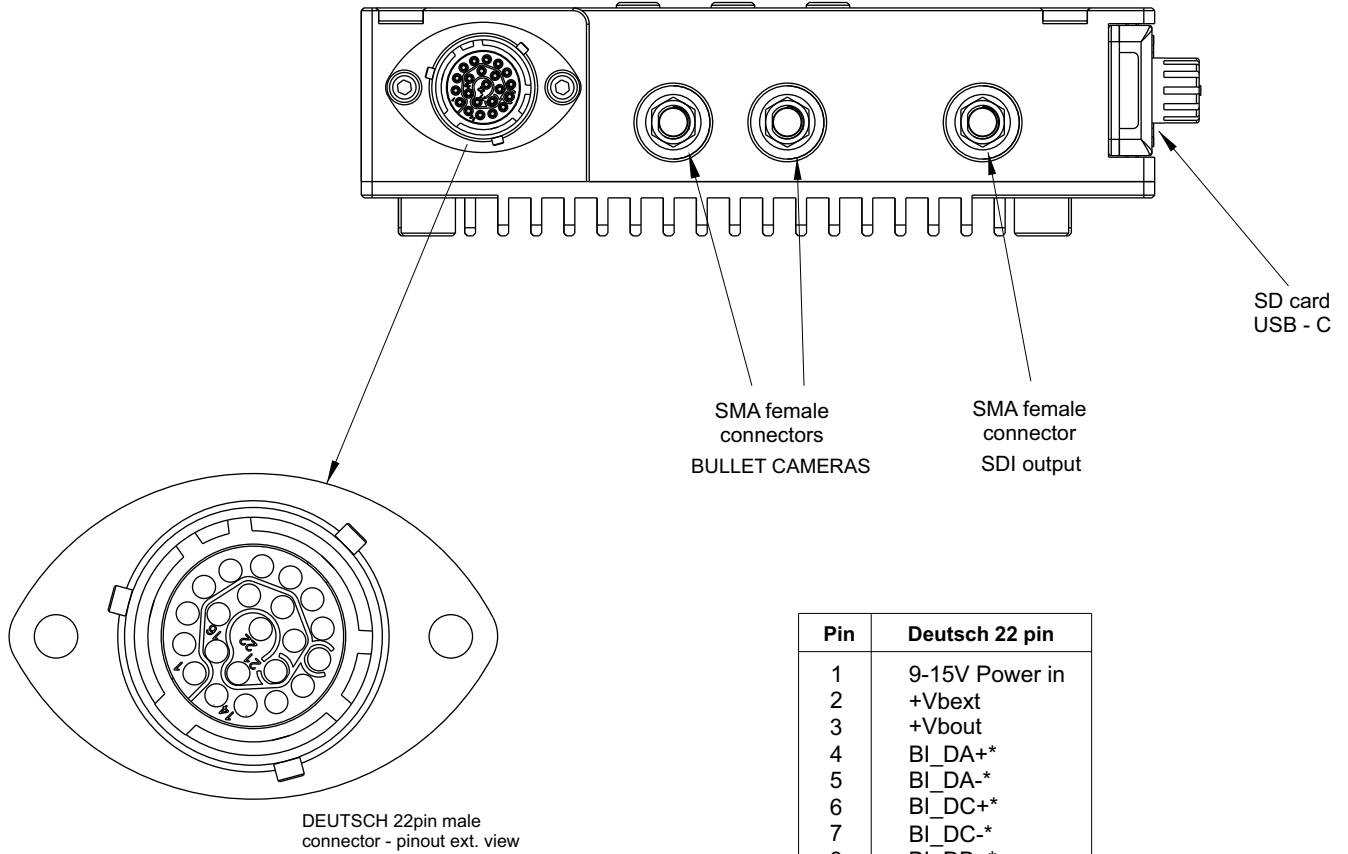

Pin	Deutsch 22 pin
1	9-15V Power in
2	+Vbext
3	+Vbout
4	BI_DA+*
5	BI_DA-*
6	BI_DC+*
7	BI_DC-*
8	BI_DB+*
9	BI_DB-*
10	GND
11	GND
12	N.C.
13	ECU CAN -
14	Ext MIC -
15	Ext MIC +
16	AIM CAN -
17	AIM CAN +
18	BI_DD-*
19	BI_DD+*
20	GND
21	ECU CAN +
22	N.C.

* Ethernet



SmartyCam 3 Dual

On-board camera with bullet cams

Standard harness

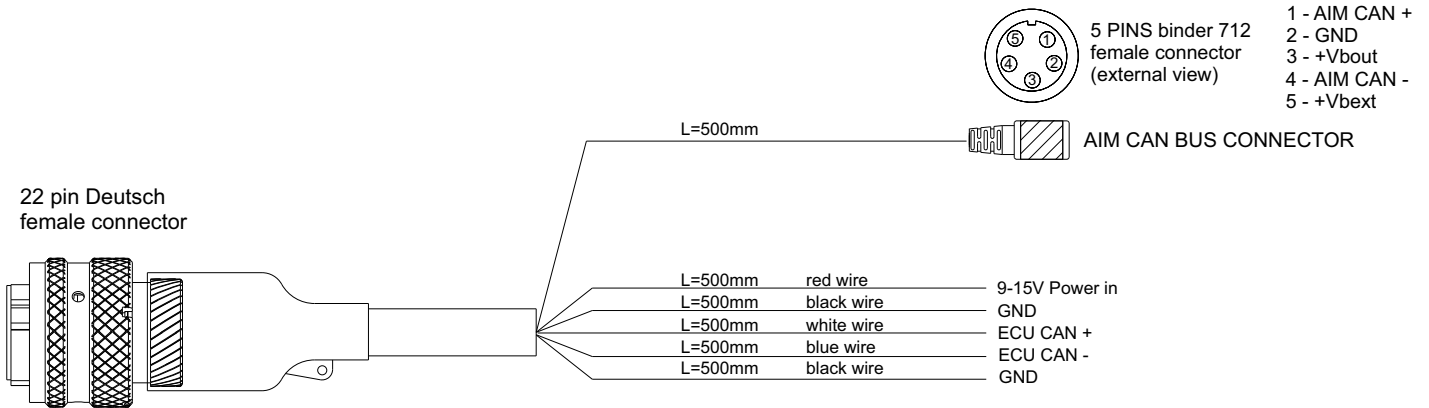

Part number

V02584300 Standard harness

Standard + Ethernet harness

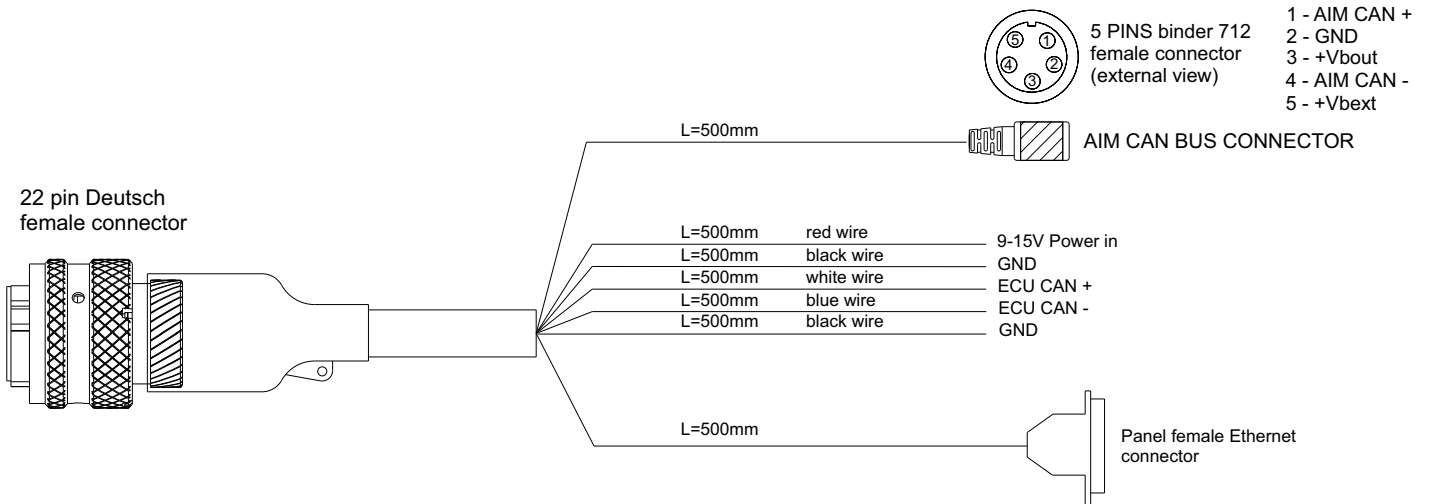

Part number

V02584350 Standard + Ethernet harness



SmartyCam 3 Dual

On-board camera with bullet cams

Full harness

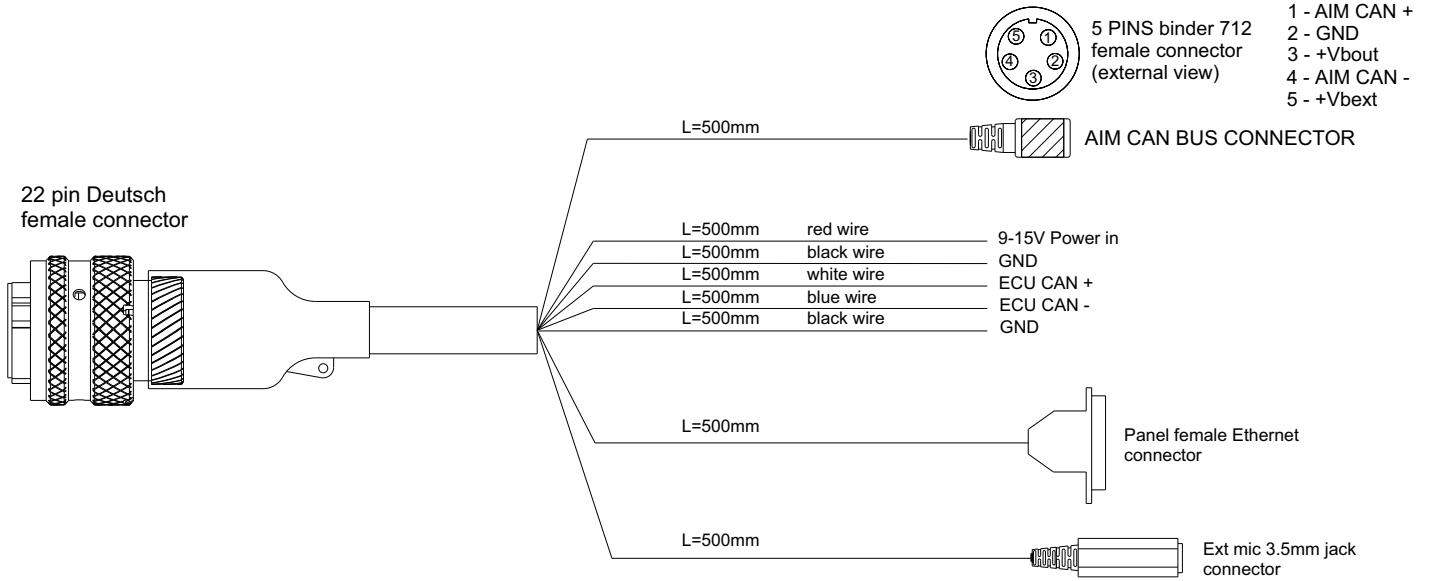

Part number

V02584290 Full harness

Connector only (pins included)

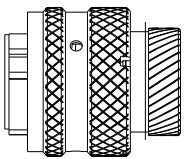

Part number

5CN822F00 Motorsport connector 22 pins + contacts



SmartyCam 3 Dual

On-board camera with bullet cams

Technical characteristics

Video format	H.264 1920 x 1080 pixels @ 60 fps
Display resolution	2.4" 240 x 320 pixels
Lens	Low distortion camera lens
CMOS sensor	Global Shutter
Field of view	67°, 84° or 120°
Internal battery	Rechargeable lithium battery
Video Out	3G-SDI
External power	9-15 Volt
Supported SD card	Up to 2 TB
Usage temperatures	-10°C/+50°C
Auto Power ON	Yes
Auto Power OFF	Yes
Auto Start/Stop Recording	Yes
Body	Anodized Aluminum
Dimensions	Main unit 154.4 x 109.6 x 42 mm Bullet camera 24 diam x 46.0 mm (120° lens) Bullet camera 24 diam x 41.0 mm (67°-84° lens)
Connectors	1 Deutsch 22 pin + 1 SMA SDI Video out + 2 SMA bullet connection + 1 USB-C
Bullet cable length	From 0.5 m to 4 m (7 lengths available)
Weight	Main unit 800 g Bullet 45 g
Waterproof	IP65







SmartyCam 3 Dual





On-board camera with bullet cams

Kits, accessories & spare parts





Kit 1 SmartyCam 3 Dual 67° lens

Description	Part number	The kit contains			
SmartyCam 3 Dual Kit with bullet cams 67°	XS3DB6767L2L200	SmartyCam 3 Dual Module 	2 x Bullet cams 67° 	2 x Bullet cam cables 2 m 	Standard + Ethernet harness 

Kit 2 SmartyCam 3 Dual 84° lens

Description	Part number	The kit contains			
SmartyCam 3 Dual Kit with bullet cams 84°	XS3DB8484L2L200	SmartyCam 3 Dual Module 	2 x Bullet cams 84° 	2 x Bullet cam cables 2 m 	Standard + Ethernet harness 

Kit 3 SmartyCam 3 Dual 120° lens

Description	Part number	The kit contains			
SmartyCam 3 Dual Kit with bullet cams 120°	XS3DB120120L2L200	SmartyCam 3 Dual Module 	2 x Bullet cams 120° 	2 x Bullet cam cables 2 m 	Standard + Ethernet harness 

Optionals/Spare Parts

Description	Part number	
SmartyCam 3 Dual Module	XS3DUAL00	
Bullet Cams		
Bullet cam 67°	XS3B06700	
Bullet cam 84°	XS3B08400	
Bullet cam 120°	XS3B12000	







SmartyCam 3 Dual



On-board camera with bullet cams

Kits, accessories & spare parts

Optionals/Spare Parts

Bullet Cam Cables	Part number	
0.5 m	V02584190	
1 m	V02584180	
1.5 m	V02584170	
2 m	V02566980	
2.5 m	V02584220	
3 m	V02584160	
4 m	V02584070	

Harnesses and connectors	Part number	
Standard harness	V02584300	
Standard + Ethernet harness	V02584350	
Full Harness	V02584290	
Motorsport Connector 22 pins + contacts	5CN822F00	

Bracket kits for bullet cams	Part number	
Roll-bar kit In the box: handlebar bracket, 60 mm arm, ball head, bullet-cam bracket	X90KSBLRB	
U-bolt kit In the box: U-bolt, 60 mm arm, ball head, bullet-cam bracket	X90KSBLTP	
Suction cup In the box: suction cup, 60 mm arm, ball head, bullet-cam bracket	X90KSBLV0	