



GT 320-350 STEERING WHEEL

USER GUIDE



AiM Srl.
Via Cavalcanti, 8
20063 Cernusco S/N (MI)
Italia
Tel. (+39) 02.9290571

Made in Italy

www.aim-sportline.com



GT 320-350 Steering Wheel

- 04 GETTING STARTED
- 12 HOW TO CONFIGURE GT STEERING WHEEL
- 18 SHIFT LIGHTS CONFIGURATION
- 22 ALARMS CONFIGURATION
- 26 PAGE CONFIGURATION
- 30 ENGAGED GEAR
- 32 POWERING ON/OFF DATA RECALL
- 34 INTERACTION WITH SMARTYCAM
- 37 ACCESSORIES
- 38 TECHNICAL DRAWINGS



Thanks

We would like to thank you for choosing GT Steering Wheel, the new wheel showing real time data sampled by EVO4 logger.

With GT Steering Wheel you can view values coming from the ECU, from accelerometers, as well as from the GPS built into the EVO4, while also receiving information from the on-board camera SmartyCam.

GT Steering Wheel also shows data coming from your Engine Control Unit via ECU Bridge, the interface module connecting the ECU to AiM visors and steering wheels.

You can also activate up to four external units from the GT Steering Wheel.

Its graphic display allows a more precise and enjoyable visualization of data. Size and make have been specifically designed for GT and Touring cars use.



Multifunctional Pushbuttons

The four buttons beside the Steering wheel display can be used to activate external units.

In the Appendix 1 you can see the related wirings.





How To install and Connect GT Steering Wheel to EVO4 and ECU Bridge

1

GT Steering Wheel must be connected via CAN bus to your EVO4 (by plugging the CAN cable into the logger "EXP" port). Its firmware version must be **43.05.02** or newer.

The wheel can also be connected to your ECU Bridge using its CAN connector.

Its firmware version must be **45.02.02**.

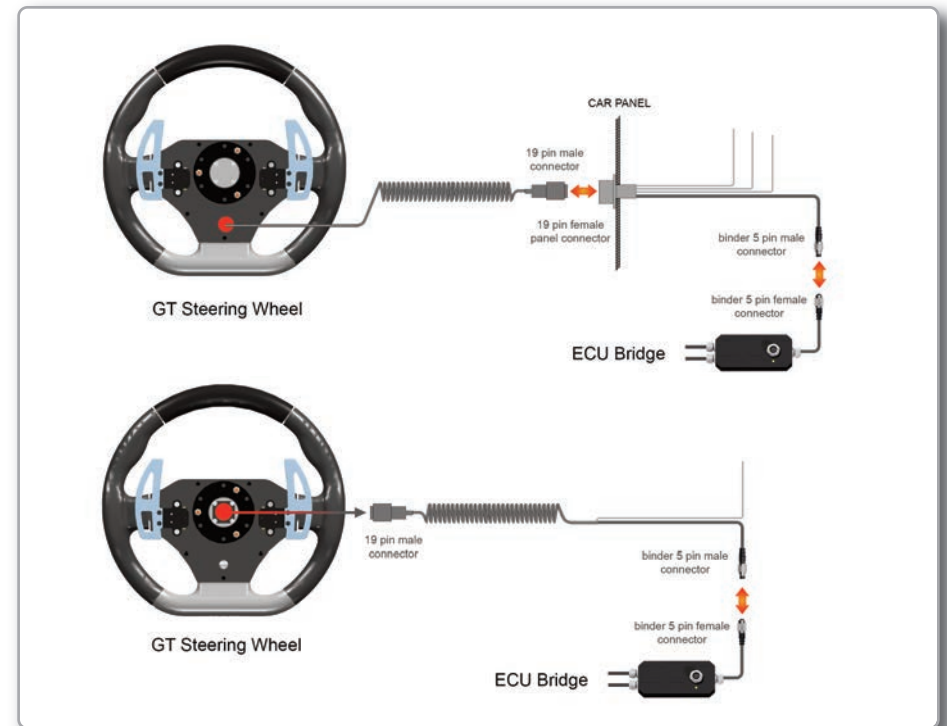
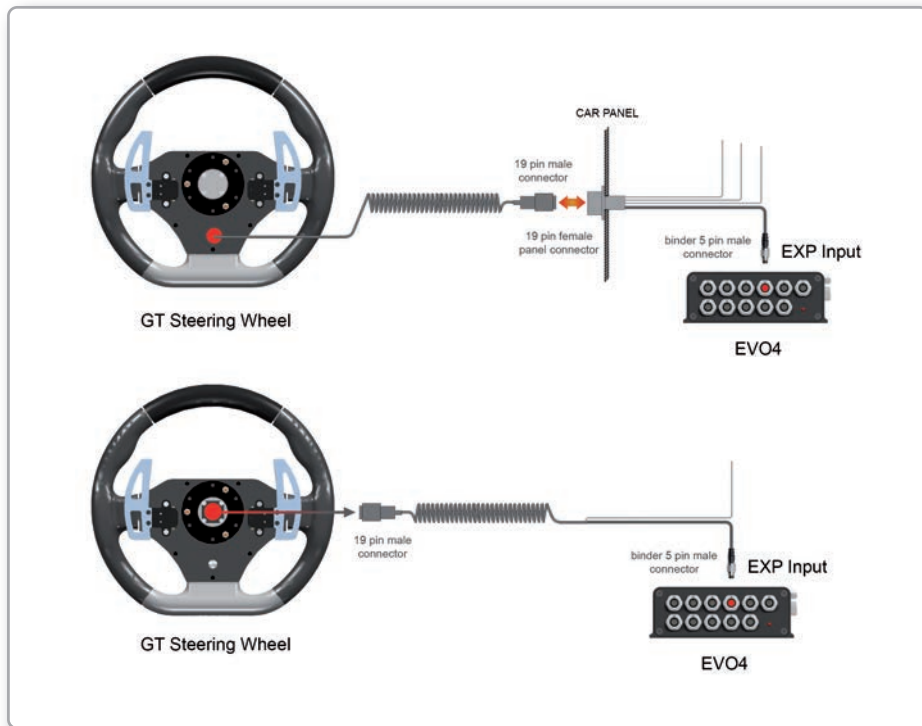

2

Please check the firmware version of your EVO4.
Connect it to PC via USB, open the Race Studio 2 software and press 'Device Info' button (1).

**3**

Alternatively, with GT Steering wheel on, **SELECT MENU>>SYSTEM MANAGEMENT >> DEVICE INFO** (2).

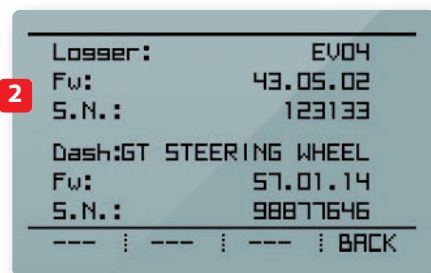
**4**

If the firmware is out of date:

If the EVO4 firmware is older than **43.05.02**, open aim-sportline.com and select **Download>>Firmware** and download the current version onto your computer.

Then run the firmware update program by following the included instructions.

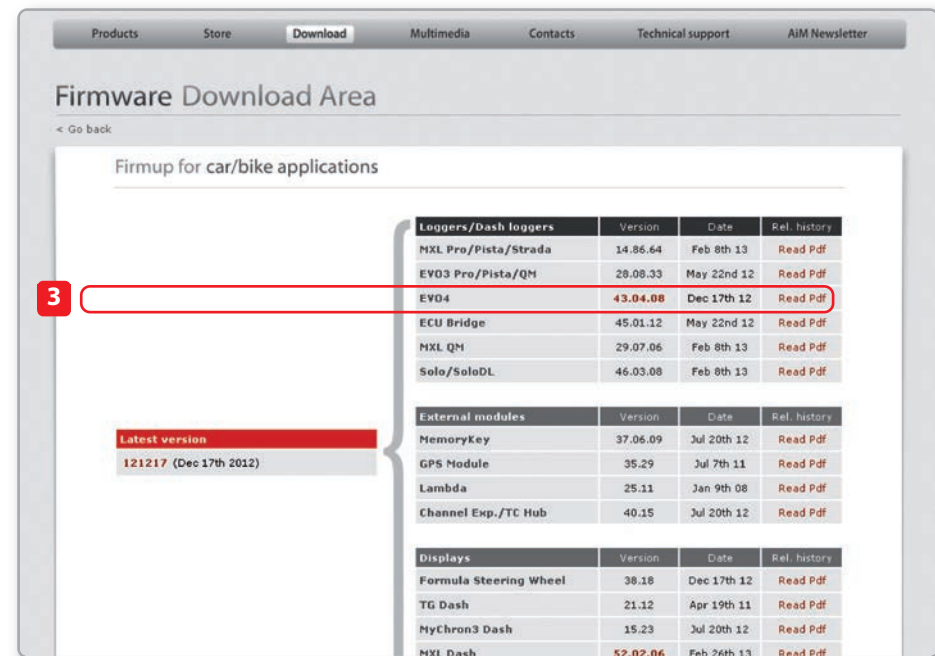

How to Configure GT Steering Wheel

1

GT Steering Wheel receives its configuration parameters from EVO4, so you must configure EVO4 in order to make GT Steering Wheel display your data correctly.

Therefore, select GT Steering Wheel as the display in EVO4 configuration.

GT Steering Wheel pages, shift lights and alarms configuration is done using the Race Studio 2 software.

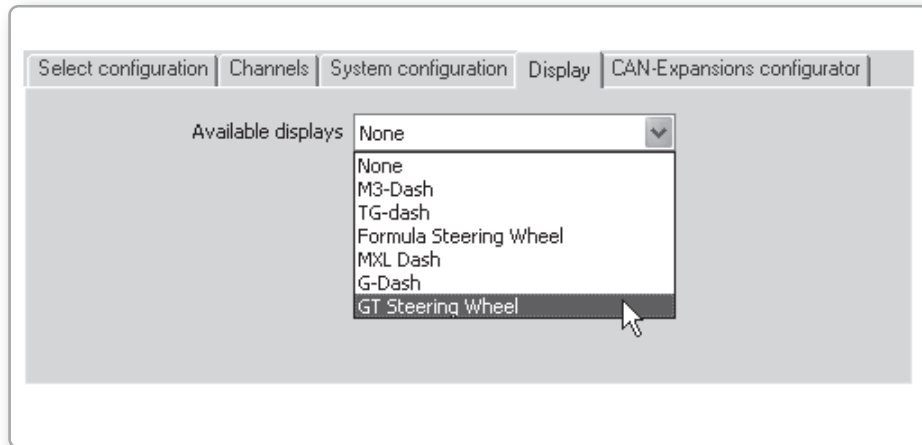

Pages Configuration

2

GT Steering Wheel is able to fully configure up to nine pages, allowing you to view your data in user definable and very customizable ways.

Select the “Pages” tab to enter the Pages Configuration panel.
Custom pages are all disabled by default.

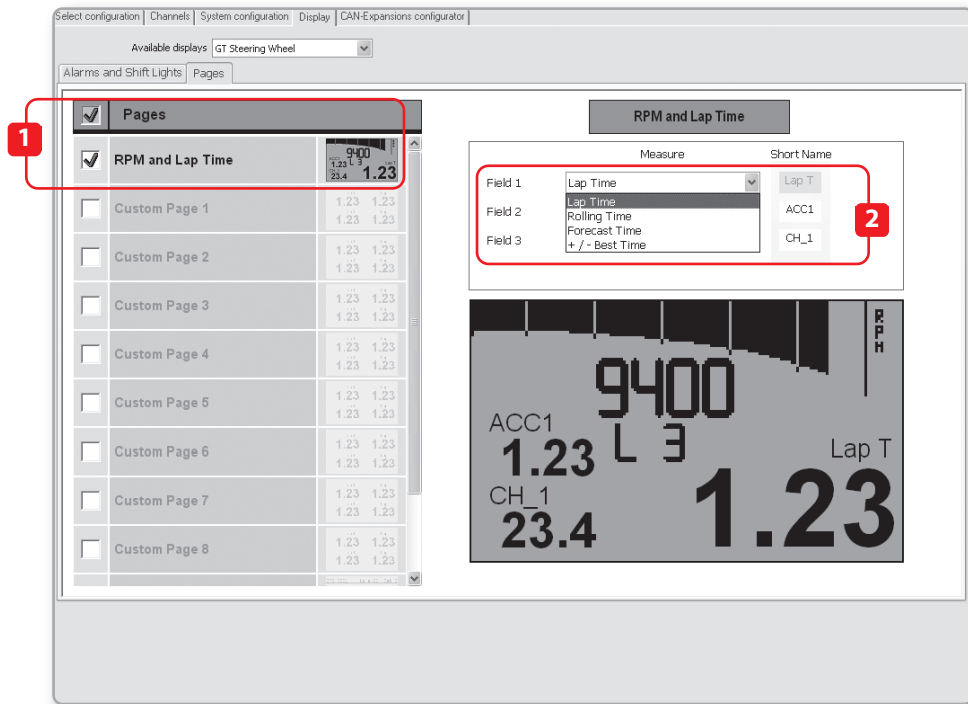

The first available page is:

RPM and lap time. (1) Here you can configure two channels and choose one of the different Lap Time visualizations: (2)

■ **Lap Time:**
shows the lap time of the previous lap;

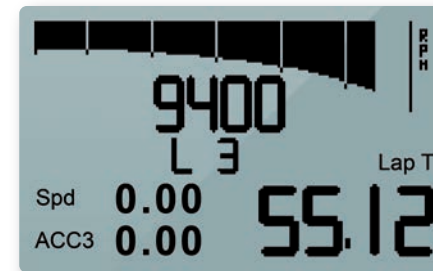

■ **Rolling Time:**
shows the lap time for ten seconds, then shows the rolling time;

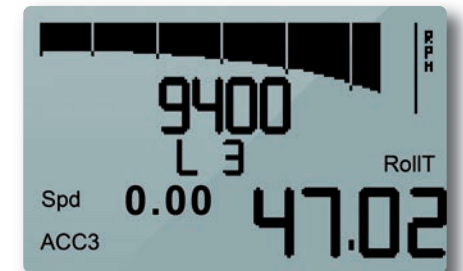

■ **Predictive Time:**
Shows a forecast of the current lap time;

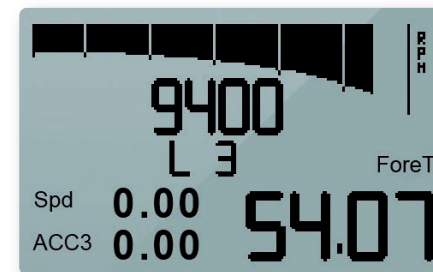

■ **+/- Best Time**
Shows a prediction of the current lap time compared with the best lap of the session.

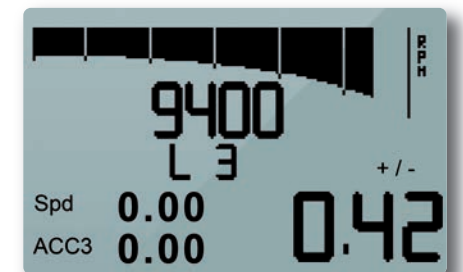

Eight Freely Configurable Pages.

You can add up to four fields per page, defining also the short name that will describe that field.

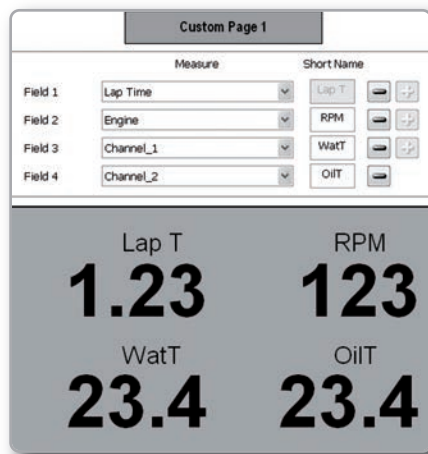

Of course, you can enable or disable each of these pages, simply clicking on the checkbox:



At the bottom of the list are the pages for Satellites and SmartyCam.

■ Satellites

Satellites shows the level of GPS signal. For the sake of precision, it is best to acquire data from at least eight satellites.

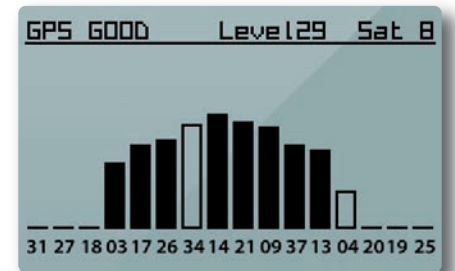
**■ SmartyCam**

SmartyCam status shows the status of the camera, when connected to the system.

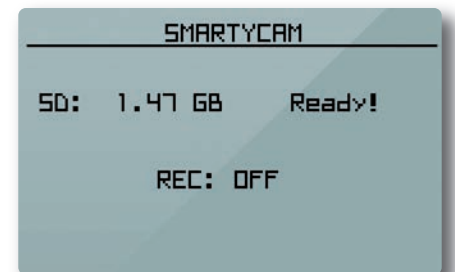

Shift Lights Configuration

3

Click **“Configure Shift Lights”** to manage the Shift Light LEDs.

The panel shown below appears and you can manage the color of each LED and the RPM threshold value at which it will turn on.

GT Steering wheel features ten LEDs, which are symmetrically managed by the five cells of the dedicated Race Studio window (see below):

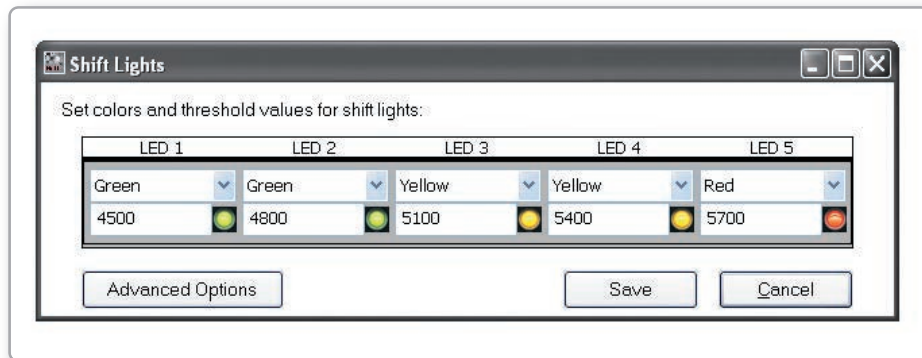

By selecting the **“Advanced options”** function, you can more deeply configure your Shift Light LEDs. The available options are:

■ **The sequence mode of the shift lights:** you can choose to leave an individual shift light LED ON or turn it OFF when the following LED has been turned ON (1).

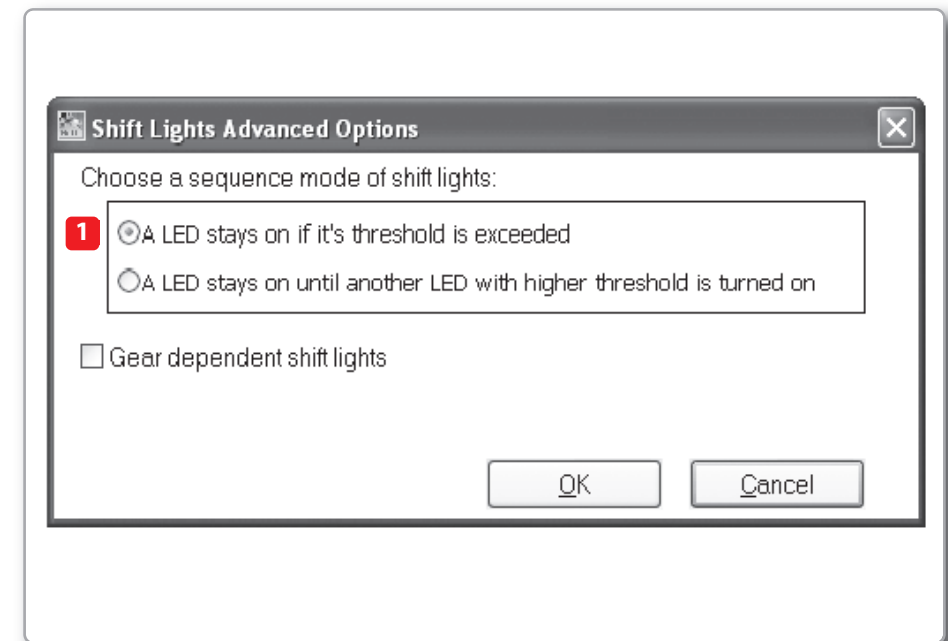

■ **The shift lights dependence upon the gear position:**

you can configure GT Steering Wheel to have different Shift Light LED thresholds for each gear position (2).

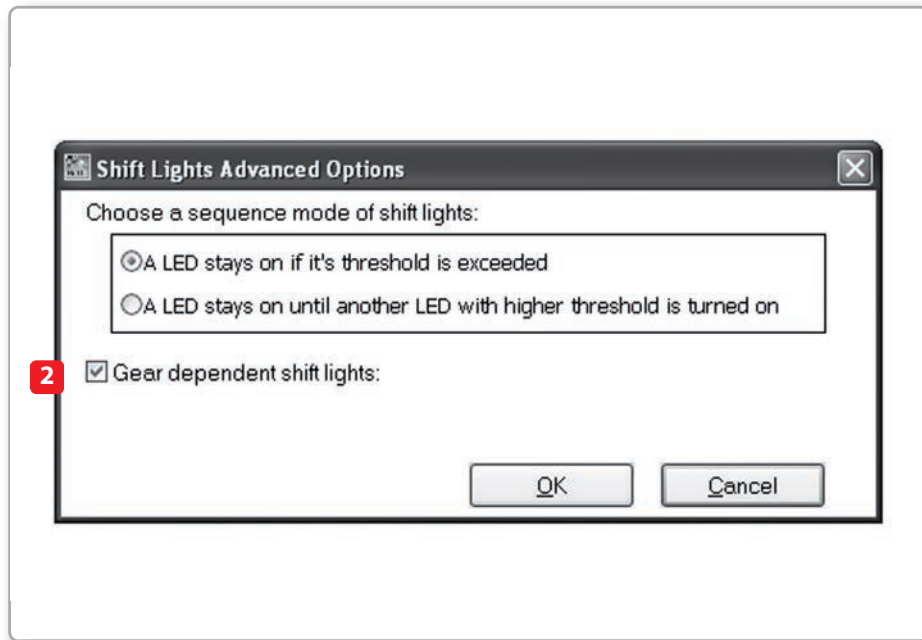

When you select this option you can set the maximum number of gears (up to nine): the view below appears.

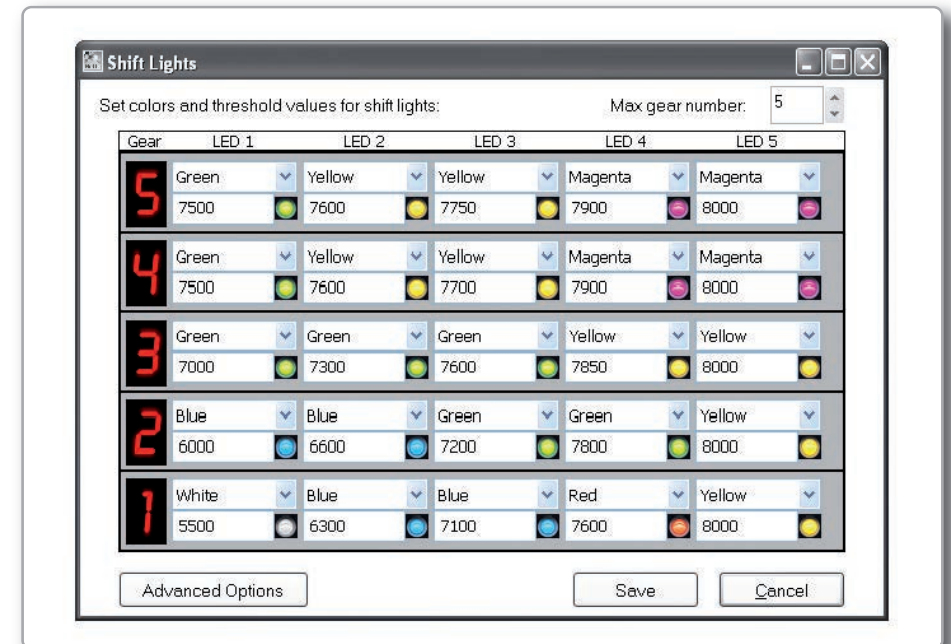

Alarms Configuration

4

Click on the “Add new alarm event” button to add new alarms or click on the icon to the right to manage existing alarms. When you click on the “Add new alarm event” button, the window below appears. Here you can select the event the system will check and the effect of that event.

1 – Fill in the DESCRIPTION field, so you can easily identify the event in the future (1).

2 – Describe the Alarm: it can be a simple event, for example “water temperature is greater than 100 C°” (2)...

3 – ...or a combination of events, for example: “water temperature is greater than 100 C°” AND “Engine RPM is greater than 6000” (1)

4 – Then assign how a LED will respond when the event (or events) occurs:

You can have G-Dash turn on the LED and you can also select the LED color and the LED behavior (solid or fast/slow blinking).

You can also define a text message (2)

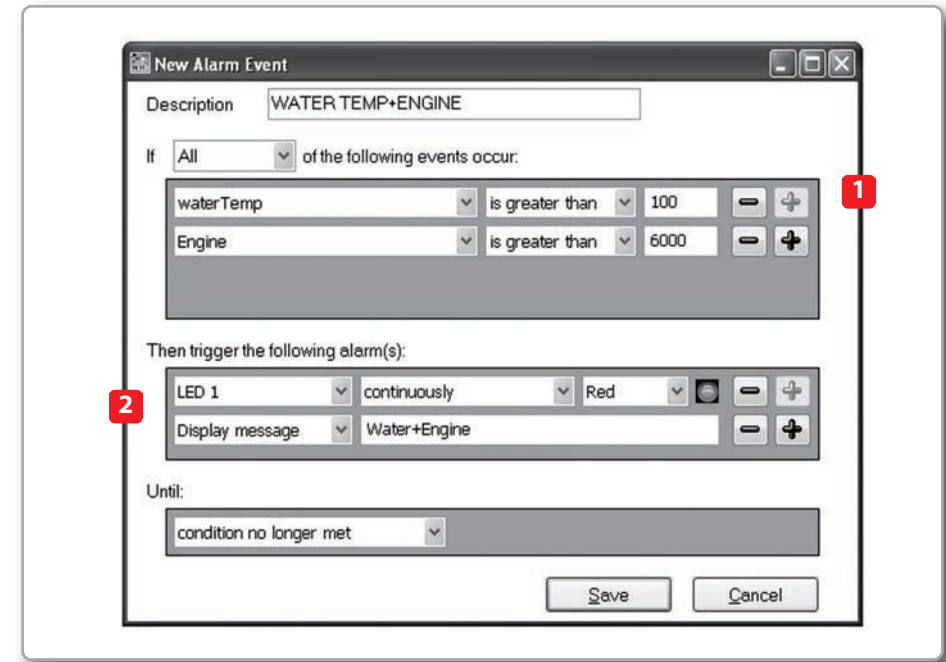
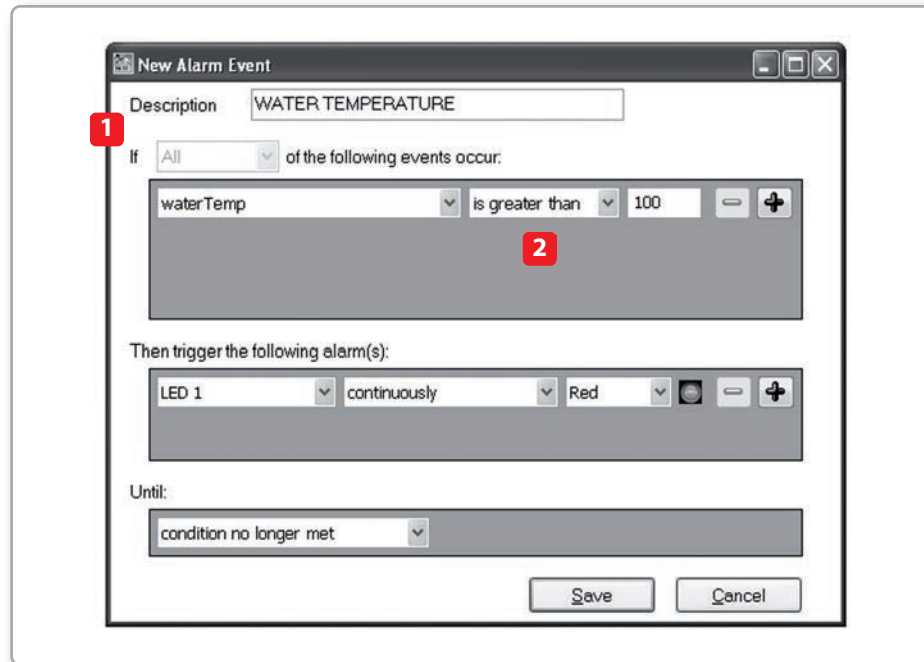

You can add different events and define the alarm as a combination of ALL the events or ANY of them (1).

Finally, you will configure the duration of the alarm (2) from four options:

- **Until the condition is no longer met**
- **Until the data is downloaded**
- **Until the device is turned off**
- **Until a button is pushed**

Once the configurations are set, a summary will appear.

Any time you need to edit the settings, just click the button and proceed.

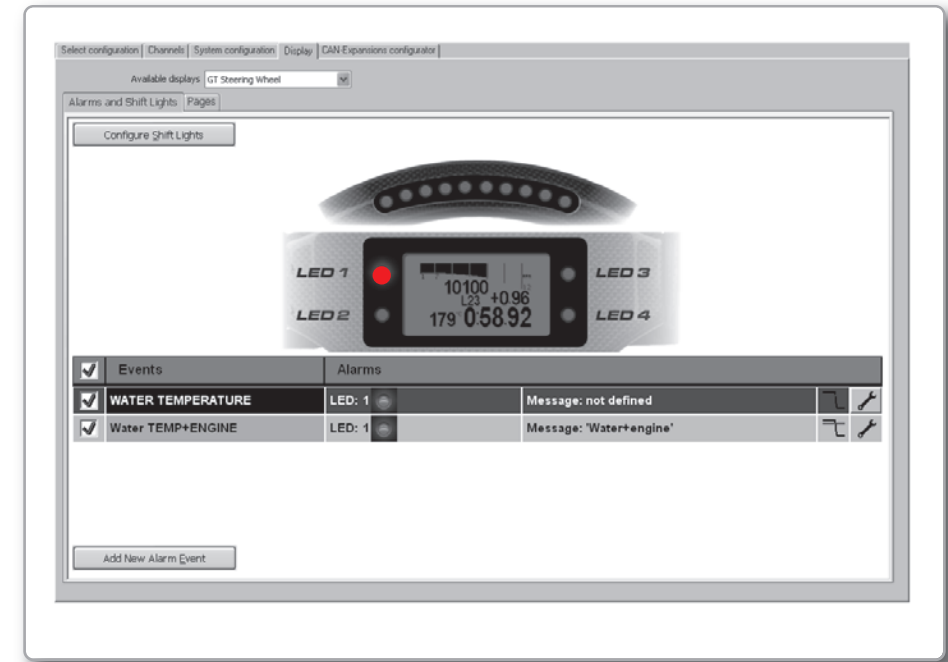
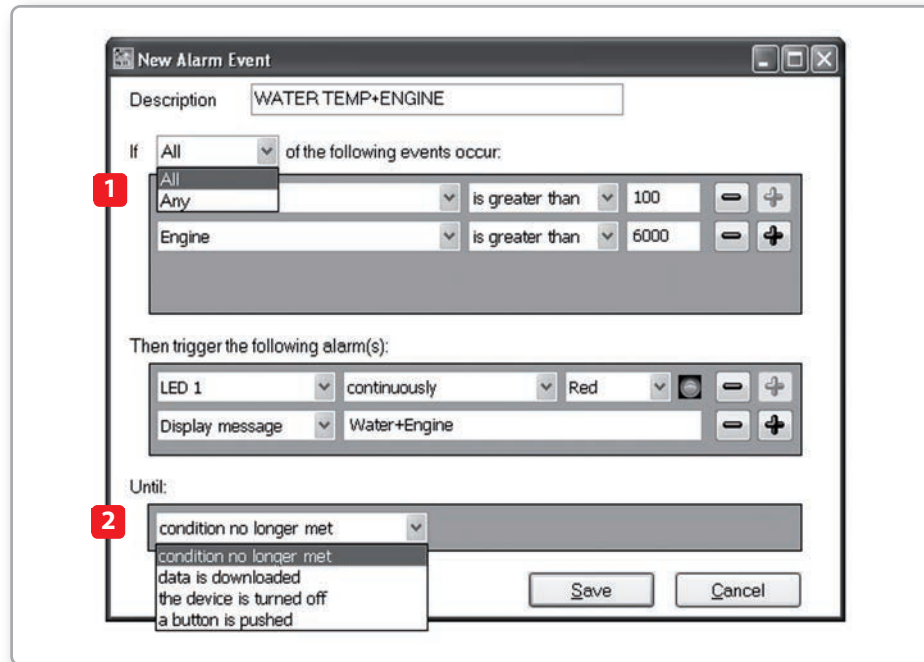

Keyboard Configuration

1

As soon as you rev your car, the **RPM and Lap Time page** is displayed: it shows RPM and lap time (showing one of the four modes explained above), together with current lap number and the additional configurable channels.



2

Pressing **MENU>>DISPLAY SETUP>>PAGE SETUP>>Page** allows you to set up to eight Custom Pages.

You decide where to show the desired variables (up to four on each page) from those sampled by the ECU, the accelerometers and the GPS values from EVO4.

To choose the variable, select it when you choose the 'Sel' menu item:



3

GPS page: this shows the number of visible satellites and their signal strength.



4

SmartyCam page: this shows the on-board camera information, when connected (see related chapter).

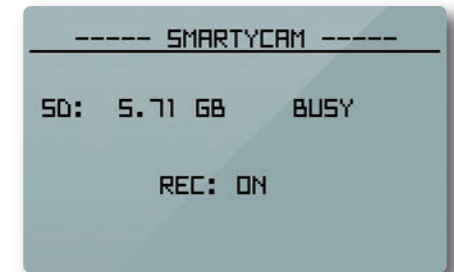

By selecting "Menu" you can also:

1

■ Set the Time/Date format.

2

■ Set the partial odometer and also track the engine running time (of up to four engines).

3

■ Choose the displayed language and view the device info (serial number and installed firmware version) of both GT Steering Wheel and EVO4 by selecting the "System Management".

4

■ Enable/disable the backlight.

■ Adjust display brightness as well as LED intensity.

Set how long the lap time will be shown on the display after crossing start/finish line.

Choose if the keyboard will always be visible ('locked' mode) or hidden ('auto hidden' mode).

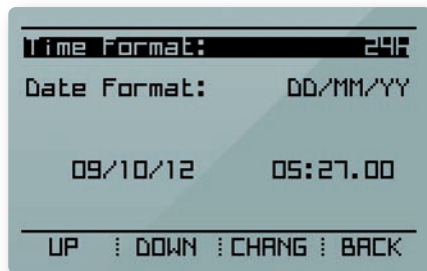

By selecting the "Create New GPS Track" item, the system stores the current GPS location and will automatically calculate lap times each time you cross that location.

Engaged Gear

Engaged gear information is provided by EVO4 and automatically displayed in the System Configuration panel if you choose:

- To set the gear:
- Using a potentiometer
- Via ECU connection

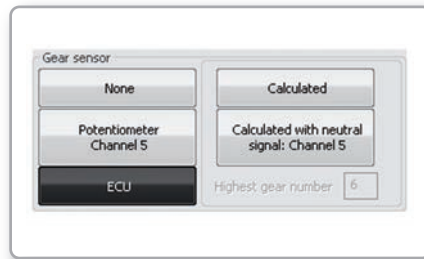

1

If you choose the **“Calculated”** mode, during the calculation GT Steering Wheel will show this icon in the RPM and Lap Time page



2

Once calculation is finished, the gear number will appear.



Gear calibration may be restarted using the keyboard by selecting

**MENU>>SYSTEM MANAGEMENT>>
RESTART GEAR CALIBRATION.**

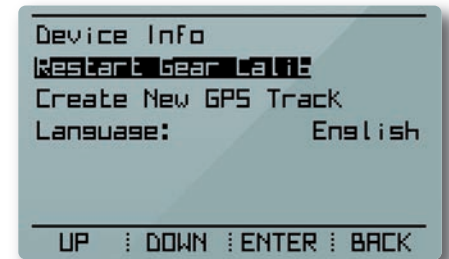

Powering On/Off

GT Steering Wheel is powered by EVO4 and turns on and off with the EVO4 with no additional user input.

As soon as EVO4 senses an RPM value, GT Steering Wheel menu will change.

The configuration functions will then show; **"LIGHT"** to quickly and conveniently backlight the display and **"TRCK"** to easily create and store the current GPS location so the system will automatically calculate lap times each time you cross that location.



Data Recall

By pressing the **"MEM"** pushbutton you can recall the data from the latest test sessions stored in memory (max. six).



The first page of the data recall screen shows a session summary: the best four laps, total distance run, total time run, Max RPM and Max Speed.

Best 4 Laps		Tot Dist
3	1:00.46	18.6km
2	1:00.99	
4	1:01.18	Tot Time
5	1:02.25	05:25.01
Max RPM: 11159		
Max SPEED: 158 km/h		
--- --- NEXT EXIT		

The second page shows all of the session laps with lap times and speeds (Min and Max).

Lap	Time	Min/Max Speed
1	1:01.38	13/134 Km/h
2	1:00.99	57/148 Km/h
3	1:00.46	56/158 Km/h
4	1:01.18	51/140 Km/h
5	1:02.25	53/135 Km/h
6	0:18.75	8/112 Km/h
--- --- NEXT EXIT		

Interaction with SmartyCam HD

In GT Steering Wheel menu, the SmartyCam page follows the GPS page:

The SmartyCam page can be found by selecting

MENU>>DISPLAY SETUP>>PAGE SETUP>>SMARTY

This page displays whether the SmartyCam is currently recording (REC: ON).

Also displayed is the amount of memory left on the memory card inserted in the SmartyCam.

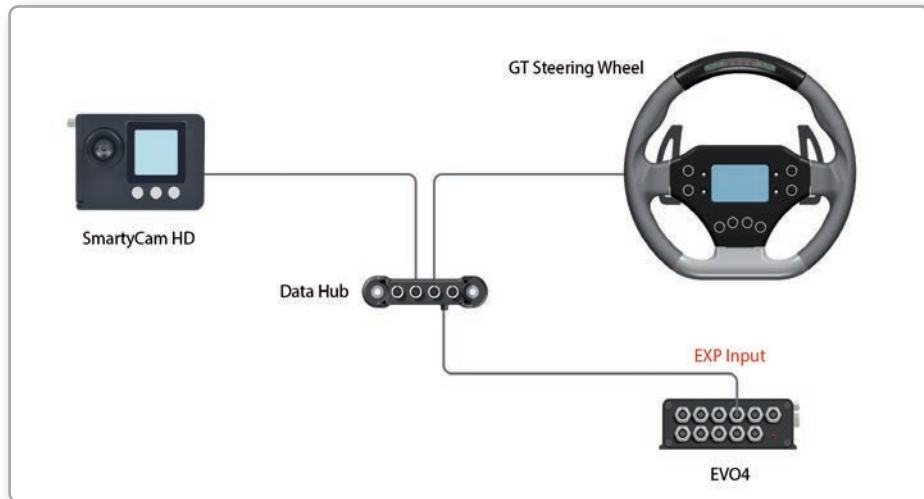

SmartyCam HD

Accessories Part Number



Paddleshifts Steering Wheel GT320
Part Number:
X07PADGT320



Paddleshifts Steering Wheel GT350
Part Number:
X07PADGT350

GT 320

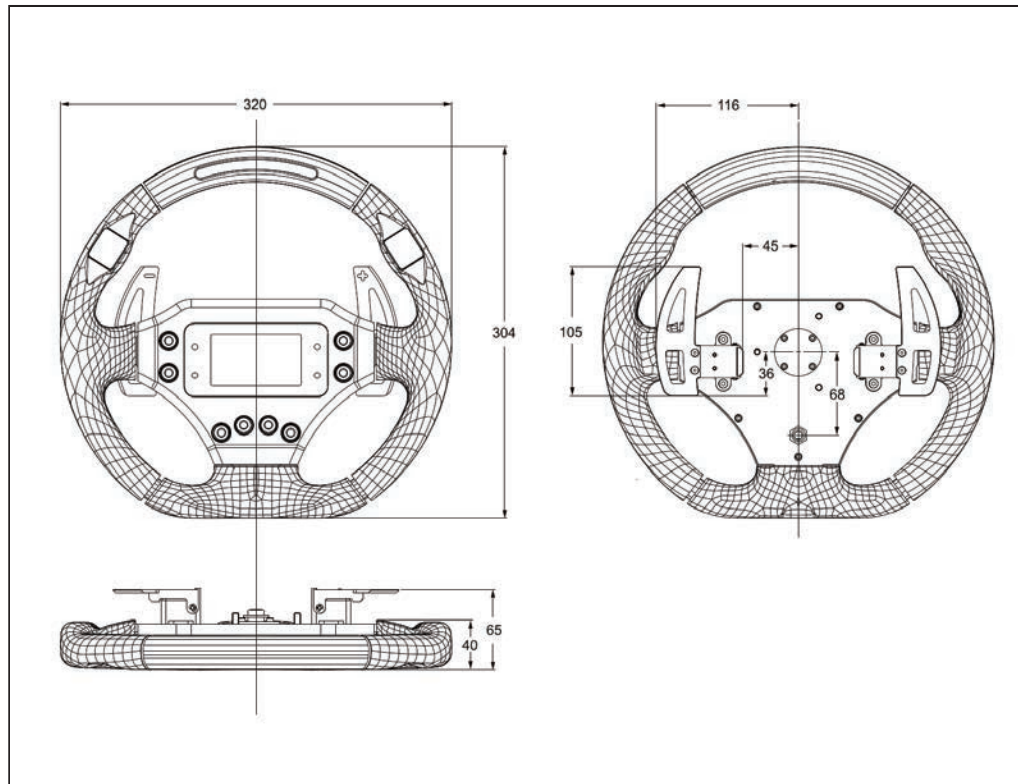

- \varnothing 320 mm
- 4 RGB Alarm LEDs
- 10 RGB Shift Lights
- 4 buttons for external units
- Graphical Display
- Grey back light
- Carbon rim and premium quality leather covering
- Waterproof IP67



GT 350

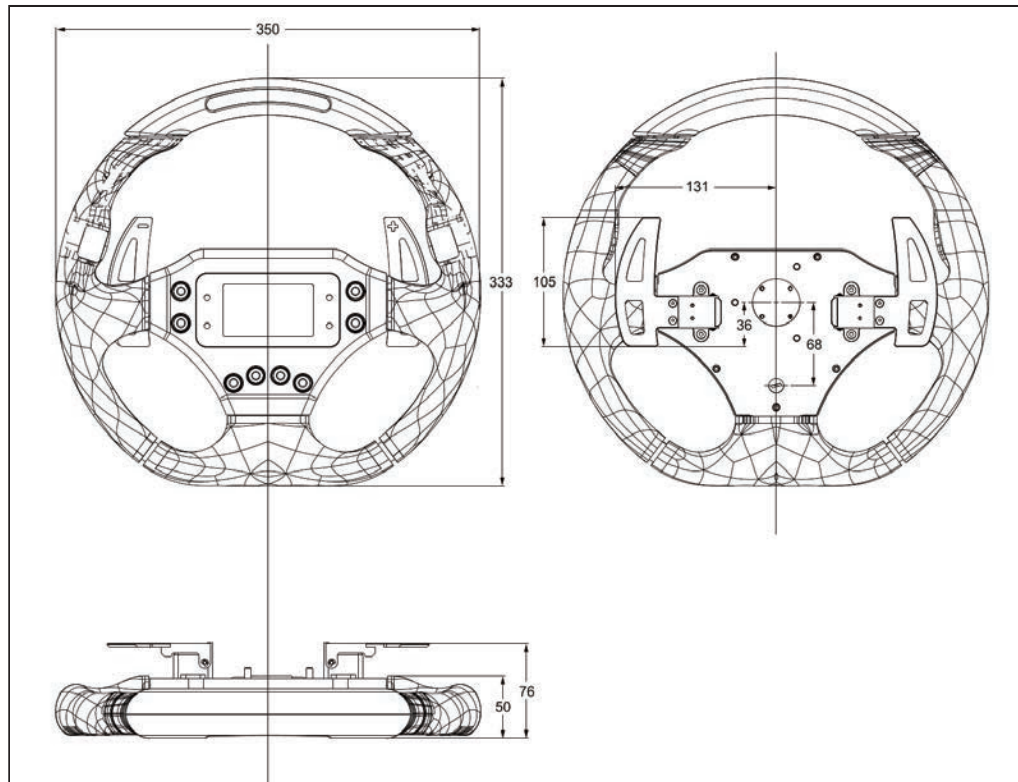

- \varnothing 350 mm
- 4 RGB Alarm LEDS
- 10 RGB Shift Lights
- 4 buttons for external units
- Graphical Display
- Grey back light
- Carbon rim and premium quality leather covering
- Waterproof IP67



Our web site aim-sportline.com is constantly updated.

Please, constantly check it and download the last versions of the firmware of your products.



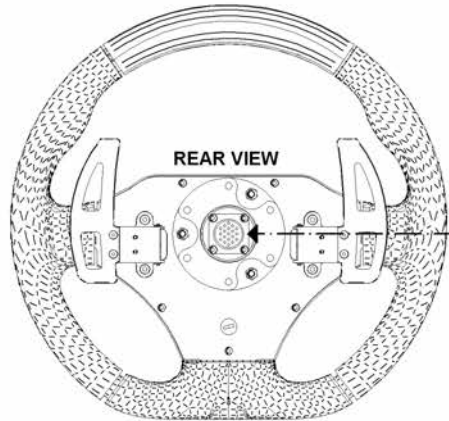
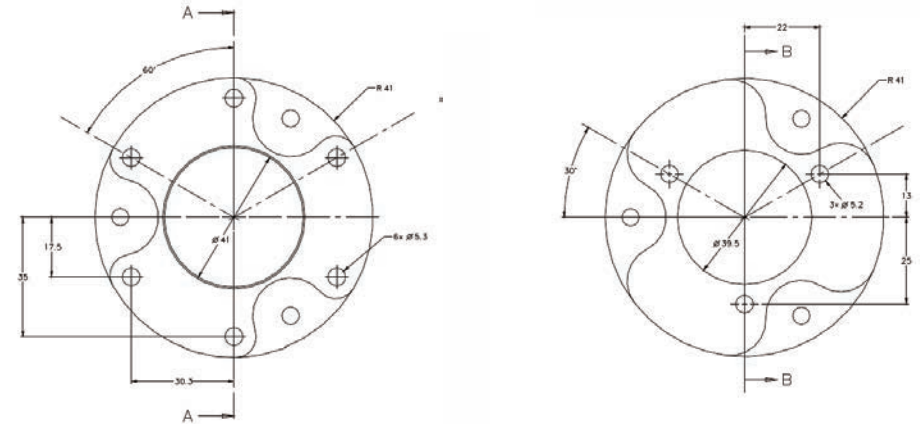
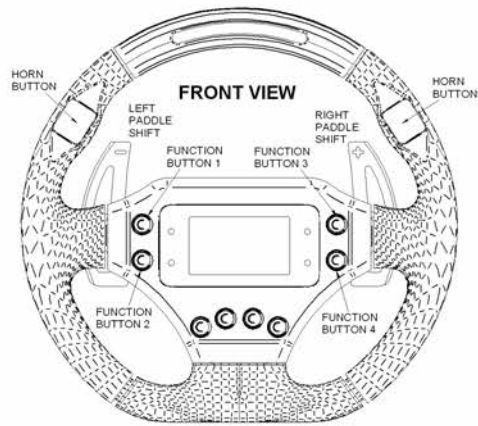

**GT STEERING WHEEL,
WITH REAR CONNECTOR VERSION,
CONNECTIONS
(WITH OMP BRACKET)**

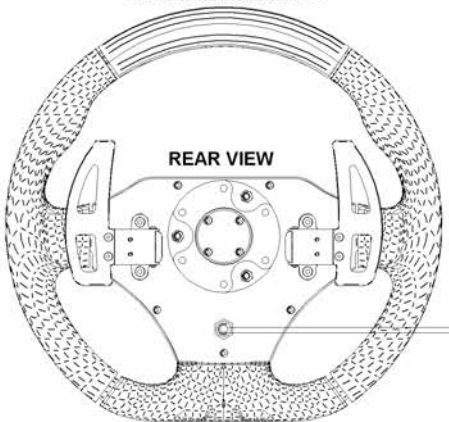
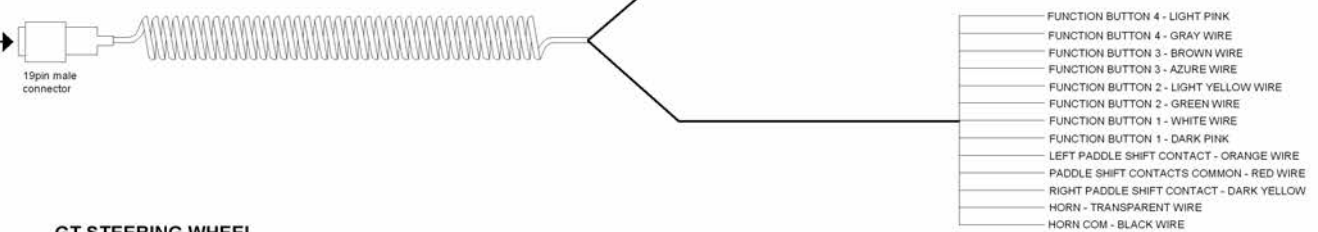

**GT STEERING WHEEL,
WITHOUT REAR CONNECTOR
VERSION, CONNECTIONS
(WITH OMP or SPA BRACKET)**

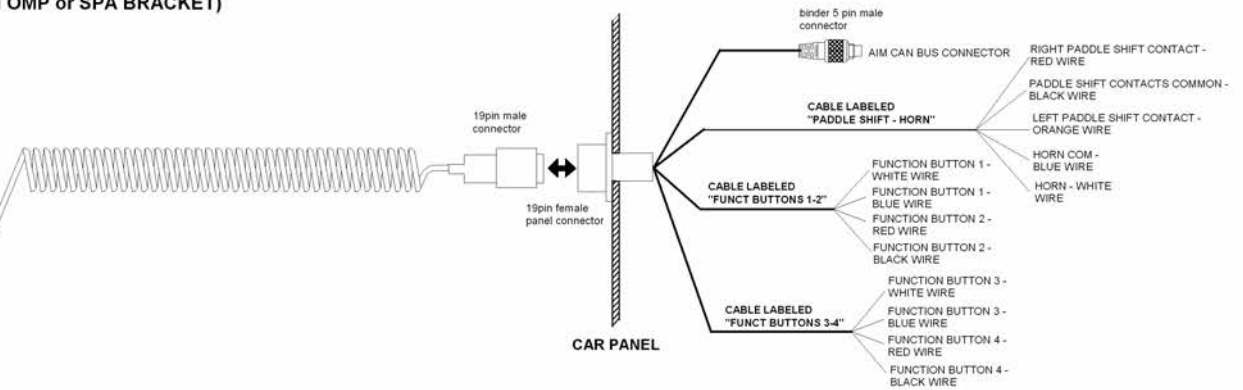

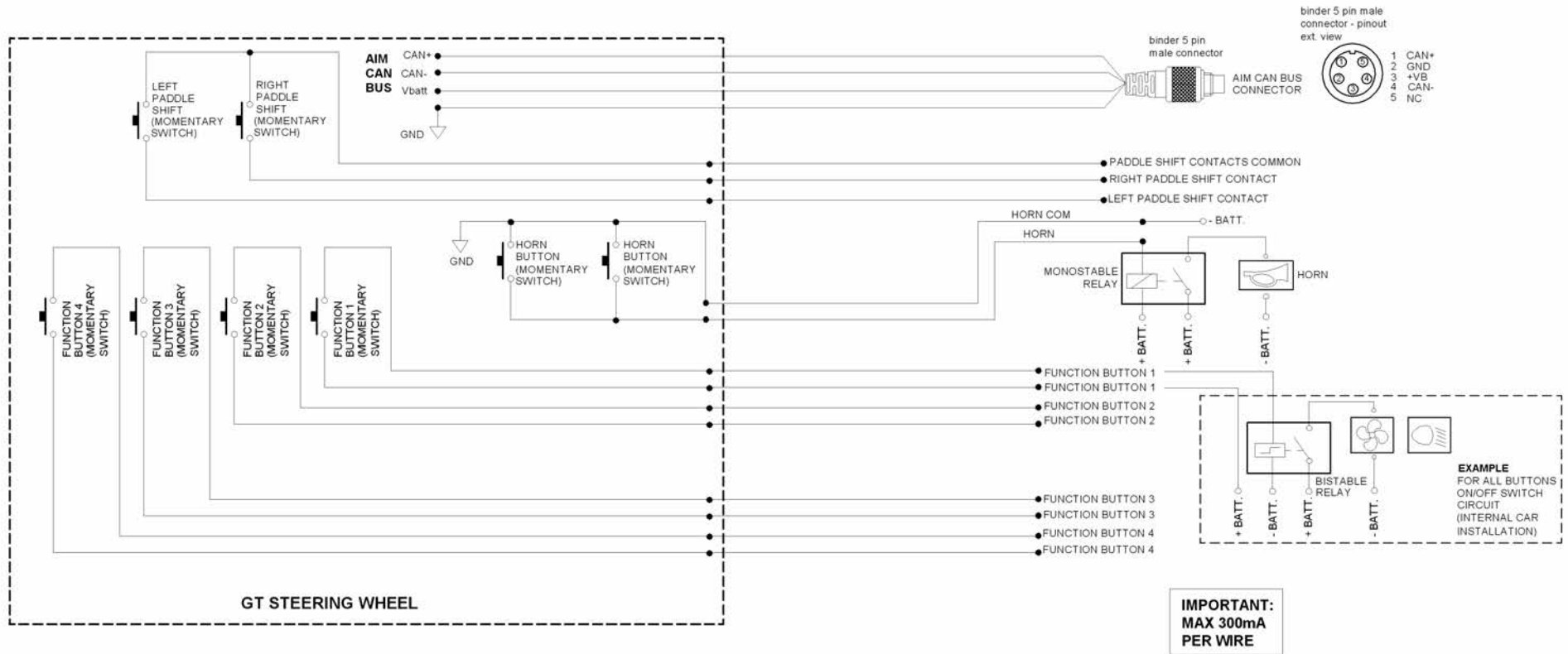

Each steering wheel is individually hand made by craftsmen who take extra care in all of the details of the manufacturing process, such as stuccoing to create room for wires, leather punching and sewing the Alcantara®, hot printing...

